

ALLEN & HEATH®



Xone:96®

USER GUIDE

Publication AP11645

Page left intentionally blank.

Limited One Year Manufacturer's Warranty

Allen & Heath warrants the Allen & Heath - branded hardware product and accessories contained in the original packaging ("**Allen & Heath Product**") against defects in materials and workmanship when used in accordance with Allen & Heath's user manuals, technical specifications and other Allen & Heath product published guidelines for a period of ONE (1) YEAR from the date of original purchase by the end-user purchaser ("**Warranty Period**").

This warranty does not apply to any non-Allen & Heath branded hardware products or any software, even if packaged or sold with Allen & Heath hardware.

Please refer to the licensing agreement accompanying the software for details of your rights with respect to the use of software ("EULA").

Details of the EULA, warranty policy and other useful information can be found on the Allen & Heath website: www.allen-heath.com/legal.

Repair or replacement under the terms of the warranty does not provide right to extension or renewal of the warranty period. Repair or direct replacement of the product under the terms of this warranty may be fulfilled with functionally equivalent service exchange units.

This warranty is not transferable. This warranty does not cover fader wear and tear.

This warranty will be the purchaser's sole and exclusive remedy and neither Allen & Heath nor its approved service centres shall be liable for any incidental or consequential damages or breach of any express or implied warranty of this product.

Conditions of Warranty

The equipment has not been subject to misuse either intended or accidental, neglect, or alteration other than as described in the User Guide or Service Manual, or approved by Allen & Heath.

Any necessary adjustment, alteration or repair has been carried out by an authorised Allen & Heath distributor or agent.

The defective unit is to be returned carriage prepaid to the place of purchase, an authorised Allen & Heath distributor or agent with proof of purchase. Please discuss this with the distributor or the agent before shipping. If the unit is to be repaired in a different country to that of its purchase the repair may take longer than normal, whilst the warranty is confirmed and parts are sourced. Units returned should be packed in the original carton to avoid transit damage.

In certain territories the terms may vary. Check with your Allen & Heath distributor or agent for any additional warranty information which may apply. If further assistance is required please contact Allen & Heath Ltd.

DISCLAIMER: Allen & Heath shall not be liable for the loss of any saved/stored data in products that are either repaired or replaced.



XONE:96 complies with the European Electromagnetic Compatibility directives 2014/30/EU and the European Low Voltage directives 2014/35/EU.

Any changes or modifications to the equipment not approved by Allen & Heath could void the compliance of the product and therefore the users authority to operate it.

XONE:96 User Guide AP11645 Issue 1

Copyright © 2018 Allen & Heath Limited. All rights reserved

Allen & Heath Limited

Kernick Industrial Estate, Penryn, Cornwall, TR10 9LU, UK

<http://www.allen-heath.com>

CONTENTS

To ensure you get the maximum benefit from the mixer, please spend some time familiarizing yourself with all of the controls and setup procedures outlined in this user guide.

For further information, please refer to the additional details available on our website, or contact our Product Support team

www.allen-heath.com/xone96

<http://support.allen-heath.com>

Warranty	3
Packed Items.....	4
Contents.....	5
Introduction	6
Top Panel Overview	7
USB 1/MIC/RTN/USB 2 Inputs, A - B.....	8
USB 1/PHONO/LINE/USB 2 Inputs, 1 - 4	10
XFADER	12
Fader Curve Switches	12
XONE:VCF Sections, FILTER 1/FILTER 2	13
XONE: VCF Reference	14
Auxiliary Return Channels, C - D	15
MASTER Section	15
PHONES 2 Section	16
BOOTH & MONITOR Sections	17
Setup Examples.....	18
Rear Panel Overview	20
Rear Panel Connectors	21
Dual Soundcard, USB 1/USB 2 (Defaults) ..	23
Driver Installation (PC).....	24
Device Installation Check (Mac and PC)	26
MIDI Control	27
MIDI Implementation.....	29
Traktor Scratch Pro2; Timecode Setup	30
Traktor Scratch Pro2; Recording a Mix	33
Block Diagram.....	34
Specifications.....	35
Panel Drawings, Weights & Dimensions.....	37
Operating Levels.....	39
Earthing	40

INTRODUCTION

Congratulations on purchasing the Allen&Heath XONE:96 DJ mixer.

The long-awaited follow-up to a genuine club classic.

A new, uncompromising analogue DJ mixer, destined to be the heart of your creativity, XONE:96 takes the legendary soul of the acclaimed Xone:92 and redelivers it, enhanced, and with state-of-the-art digital connectivity.

It's all here. The huge, detailed, space-shaking analogue sound that only Xone delivers. A refined, precision 4-band EQ. Unrivalled dual Xone:VCF filters with CRUNCH harmonic distortion. And a dual 32-bit USB soundcard (24 Channels @ 96kHz) with Traktor Scratch certification right out of the box.

XONE:96 lets you connect your whole rig, from laptops and turntables, to pedals, synths, mics and drum machines. Two dedicated FX sends, four stereo input channels (with 4-Band EQ), two stereo input channels with all new 3-Band Parametric EQ + two auxiliary stereo return channels. And a separate master insert for your outboard hardware.

Explore new possibilities with a familiar layout of beautifully tactile controls. And rely on the industrial build quality that exceeds the demands of relentless back-to-back performances, night after night.

XONE96: You mixed. We listened.

TOP PANEL OVERVIEW

Please familiarize yourself with all of the controls and functions detailed in the following pages and referencing the numbers shown in the TOP PANEL OVERVIEW below and REAR PANEL OVERVIEW on p.20.

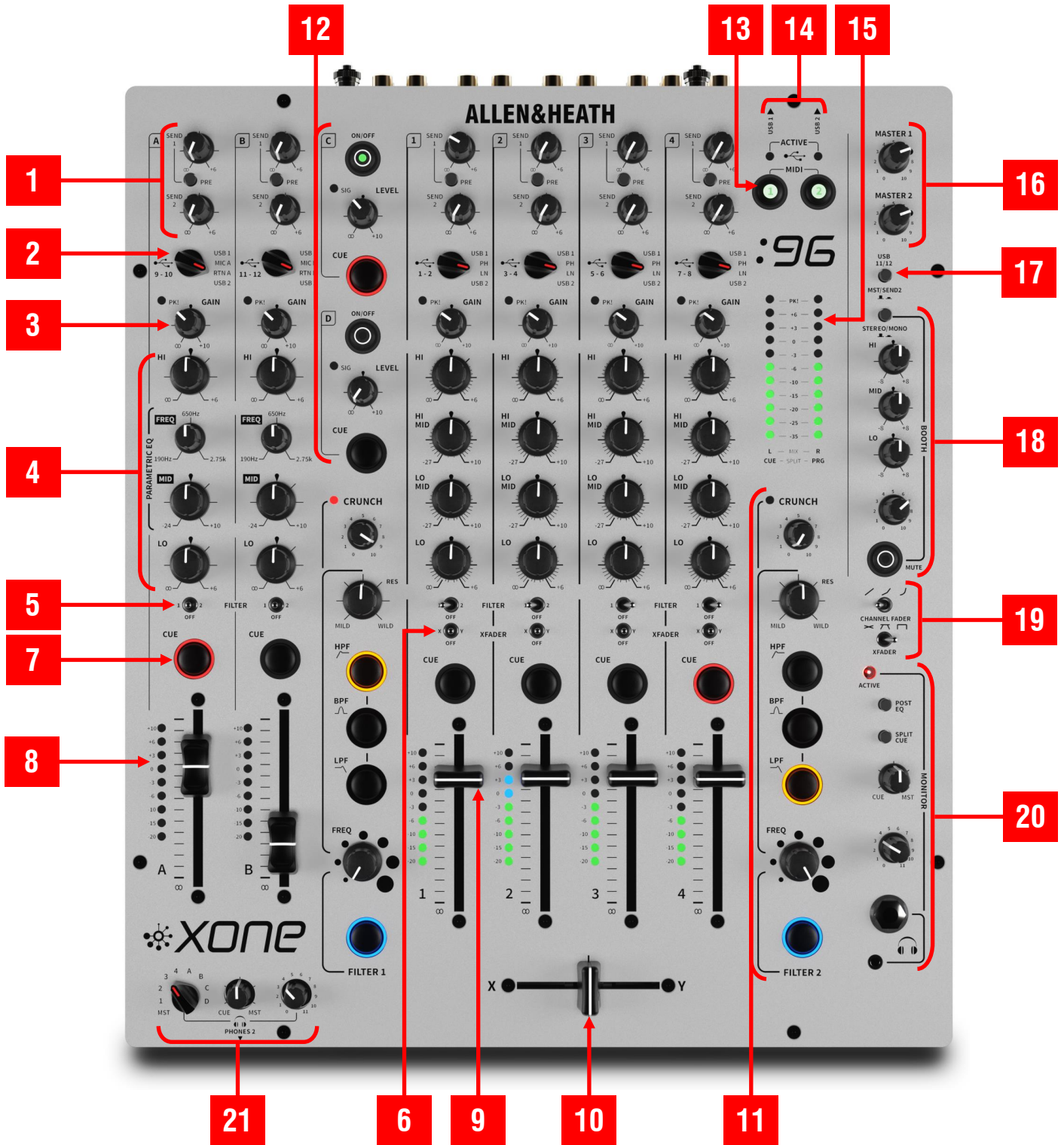

INPUT CHANNELS A - B: USB 1/MIC/RTN/USB 2



1 SEND 1 & SEND 2 Controls

Control the levels of channel audio sent to external effects hardware connected via rear panel SND1 and SND2 outputs. SEND 1 is switchable pre/post-FADER and also routes audio to internal soundcard inputs USB 9/10. SEND 2 is fixed post-FADER, with switched option for routing audio to internal soundcard inputs USB 11/12. See p.23.

2 Channel Input Select Switch

Switch CH A and CH B inputs between USB1, MIC, RTN, or USB 2 sources. Switches also send MIDI NOTE ON/OFF messages to USB1, USB 2 and MIDI OUT ports. See p.28 for information.

3 Channel GAIN Control

Adjusts the Channel input sensitivity to compensate for different audio signal source levels. $-\infty/+10$ dB. If a **PK!** LED illuminates, turn the corresponding channel GAIN level *down*.

4 Channel Equalizer

Auxiliary Channels A and B are equipped with new extended asymmetric 3-BAND EQ, providing +6dB boost and full attenuation ('kill') for HI and LO frequencies and +10dB boost/-24dB cut, swept parametric MID for detailed and creative frequency control.

EQ cut-off frequencies are set at:

HI	3 kHz	(High Frequency, <i>treble</i>)
MID	190 Hz - 2.75kHz	(Parametric, <i>sweep</i>)
LO	180 Hz	(Low Frequency, <i>bass</i>)

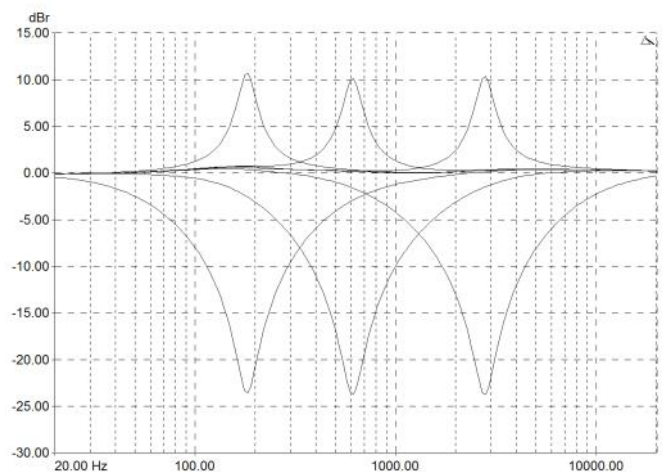
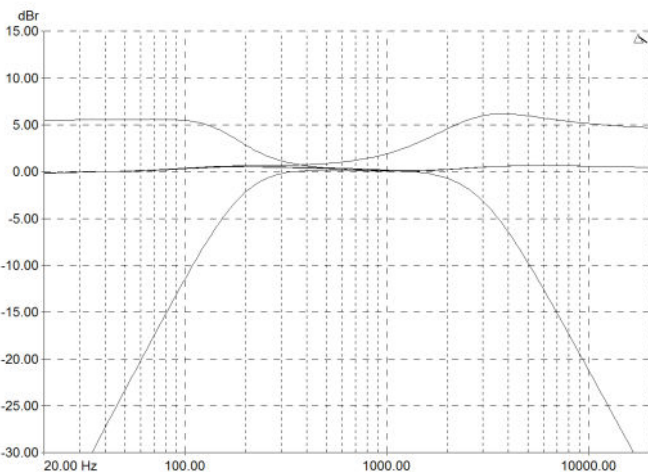

INPUT CHANNELS A - B continued

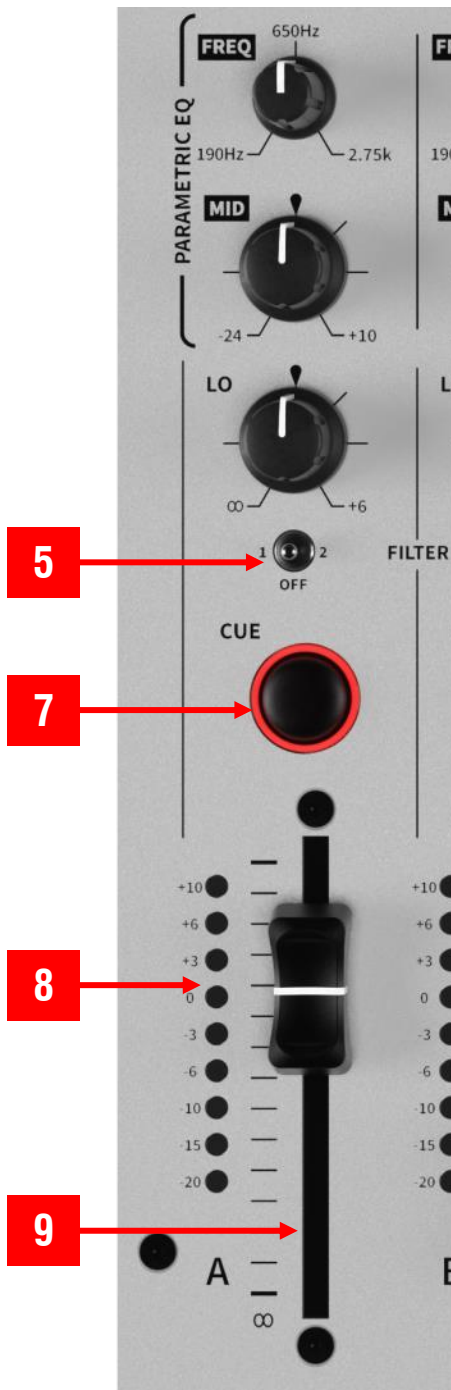

5 Channel FILTER Assign Switches

Switch to route post-GAIN / post-EQ / post-FADER level channel audio to FILTER 1 (left) or FILTER 2 (right), or direct to the LR MIX bus when OFF (centre).

7 Channel CUE Switch

Press to listen to the channel audio levels from MONITOR headphones outputs and to view pre-LR MIX levels on the main LR MIX meters. Switches illuminate RED when active. Default switch setting is AUTO-CUE; switches remain on until the switch is pressed again or another CUE is selected. See below for details to enable the LATCHING-CUE Mode. CUE is also enabled for MIDI control. See below.

8 Channel Meter

Displays the channel's input source signal level. Channel audio input is metered at post-GAIN / post-EQ and pre-FADER level, to display the affect of adjusting EQ on input levels before routing audio to the LR MIX. Channel GAIN control should be set so the meter averages around 0 with loudest peaks around +6. If the +10 LED is illuminated continuously, turn the channel GAIN, or EQ controls *down*.

9 Channel Fader

XONE:96 features new custom-designed 60mm stereo linear VCA channel faders to adjust channel audio levels from fully off (∞) to fully on (unity). CH A and CH B faders are fully analogue, premium faders offering smooth performance and precise control. Perfectly balanced and built to last.

LATCHING-CUE Mode enables CUE switches to remain active when selecting another channel CUE. Any active CUE is deactivated by pressing the switch again. The option can be enabled, on-the-fly, as follows:

- Press and hold any Filter Type Select switch (HPF, BPF, LPF) on both FILTER 1 and FILTER 2 simultaneously for 3s; MIDI 1 and MIDI 2 switches blink rapidly to indicate CUE setup mode.
- Press any channel CUE switch; MIDI 1 and MIDI 2 switches stop blinking and LATCHING-CUE is enabled

NOTE: The setup mode times out automatically after 3s. Active CUE is deactivated by pressing the switch again.

- Repeat the process to re-enable AUTO-CUE. The current setting is stored when the mixer is powered OFF.

MIDI Control

- CUE switches send MIDI NOTE ON/OFF messages to the rear panel MIDI OUT port, and to USB 1 and USB 2 ports when the corresponding MIDI 1/ 2 switch is active.
- CUE switches can also be remotely controlled by MIDI output from USB 1 and USB 2. See p.28 for details.

INPUT CHANNELS 1 - 4: USB 1/PHONO/LINE/USB 2



1 SEND 1 & SEND 2 Controls

Control the levels of channel audio sent to external effects hardware connected via rear panel SND1 and SND2 outputs. SEND 1 is switchable pre/post-FADER and also routes audio to internal soundcard inputs USB 9/10. SEND 2 is fixed post-FADER, with switched option for routing audio to internal soundcard inputs USB 11/12. See p.23.

2 Channel Input Select Switch

Switch CH A and CH B inputs between USB1, MIC, RTN, or USB 2 sources. Switches also send MIDI NOTE ON/OFF messages to USB1, USB 2 and MIDI OUT ports. See p.28 for details.

3 Channel GAIN Control

Adjusts the Channel input sensitivity to compensate for different audio signal source levels. $-\infty/+10$ dB. If a **PK!** LED illuminates, turn the corresponding channel GAIN level *down*.

4 Channel Equalizer

Stereo Channels 1 - 4 are equipped with a refined asymmetric XONE 4-BAND EQ, providing +6dB boost and full attenuation ('kill') for HI and LO frequencies and with powerful +10dB boost/-27dB cut for HI MID and LO MID frequencies.

EQ cut-off frequencies are set at:

HI	3 kHz	(High Frequency, <i>treble</i>)
HI MID	1.1 kHz	(Upper Midrange Frequency)
LO MID	350 Hz	(Lower Midrange Frequency)
LO	180 Hz	(Low Frequency, <i>bass</i>)

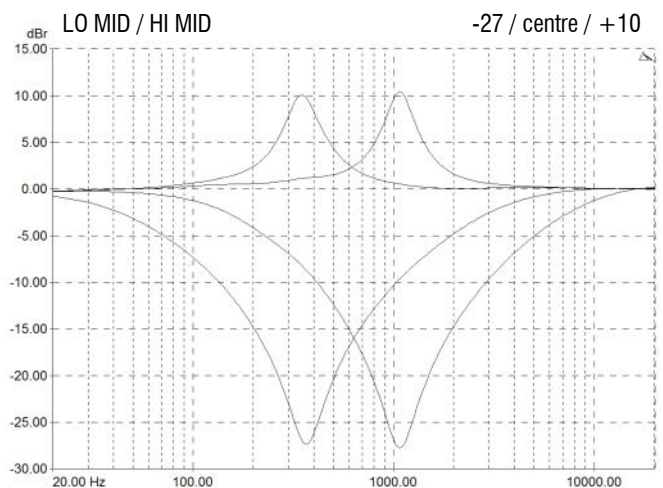
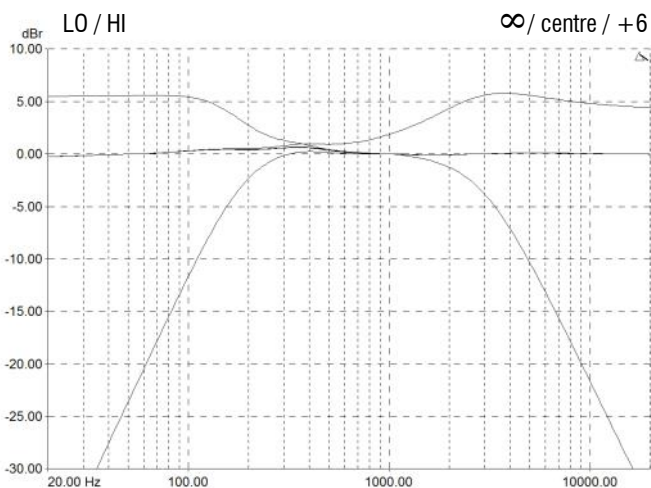

INPUT CHANNELS 1 - 4 continued

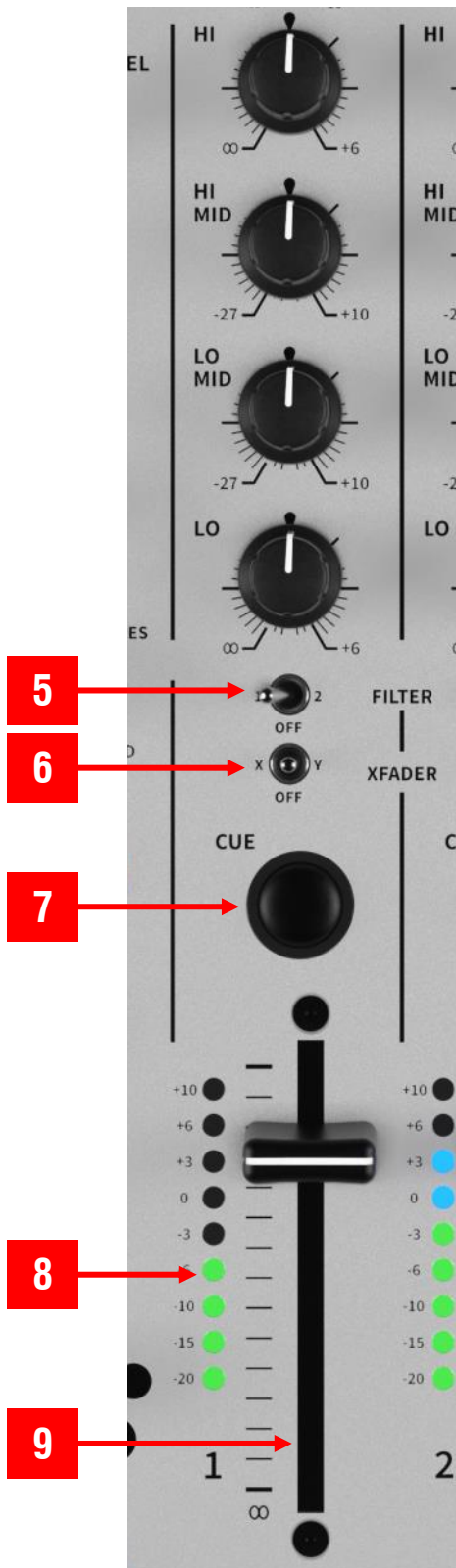

5 Channel FILTER Assign Switches
Switch to route post-GAIN / post-EQ / post-FADER level channel audio to FILTER 1 (left) or FILTER 2 (right), or direct to the LR MIX bus when OFF (centre).

6 XFADER Assign Switches
Switch to route post-GAIN / post-EQ / post-FADER level channel audio to X (left) or Y (right), side of the XFADER, or direct to the LR MIX bus when OFF (centre).

7 Channel CUE Switch
Press to listen to the channel audio levels from MONITOR headphones outputs and to view pre-LR MIX levels on the main LR MIX meters. Switches illuminate RED when active. Default switch setting is AUTO-CUE. Refer to p.9 for details. CUE switches are also enabled for MIDI control. See below.

8 Channel Meter
Displays the channel's input source signal level. Channel audio input is metered at post-GAIN / post-EQ and pre-FADER level, to display the affect of adjusting EQ on input levels before routing audio to the LR MIX. Channel GAIN control should be set so the meter averages around 0 with loudest peaks around +6. If the +10 LED is illuminated continuously, turn the channel GAIN, or EQ controls *down*.

9 Channel Fader
XONE:96 features new custom-designed, user replaceable, 60mm stereo linear VCA channel faders to adjust channel audio levels from fully off (∞) to fully on (unity). Perfectly balanced for smooth performance and precise control. CH1 - 4 faders are also enabled for MIDI control. See below.

MIDI Control

- CUE switches send MIDI NOTE ON/OFF messages to the rear panel MIDI OUT port, and to USB 1 and USB 2 ports when the corresponding MIDI 1/ 2 switch is active.
- CUE switches can also be remotely controlled by MIDI output from USB 1 and USB 2.
- CH1 - 4 faders send MIDI CC messages to the rear panel MIDI OUT port, and to USB 1 and USB 2 ports when the corresponding MIDI 1/ 2 switch is active. See p.28 for details

X FADER

10 In the cross-fader position, XONE:96 implements the industry-favourite [mini innoFADER](#) as standard.

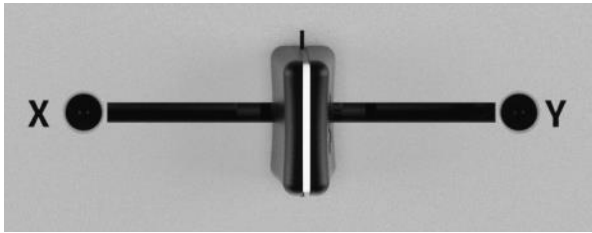

The XFADER is a VCA (voltage controlled amplifier) that also affects the level of signals routed to the Filters. Use to fade between audio from CH 1 - 4 assigned to the X (Left), or Y (Right) side of the XFADER, typically to fade smoothly into a new music track, to creatively layer sounds, or for scratch and cut mixing.

MIDI Control

- The X FADER also sends MIDI CC messages to the rear panel MIDI OUT port, and to USB 1 and USB 2 ports when the corresponding MIDI 1/ 2 switch is active. See p.28 for details.

FADER CURVE SWITCHES, XFADER / CH 1 - 4

19 Fader Curve Switches



CHANNEL FADER

Selects a global fader response for Stereo Input Channels 1- 4. Switch between constant power, dipped, or fast-cut to suit scratch and cut mixing styles.

XFADER

Selects the response curve for the cross-fader. Switch between constant power, transition, or fast-cut to suit scratch or cut mixing.

The images below illustrate the curves for each setting

CHANNEL FADER

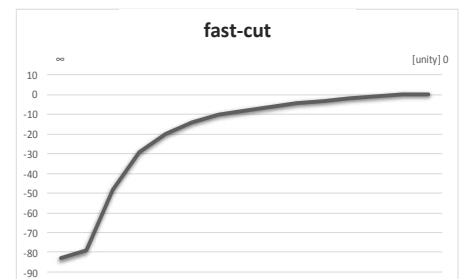
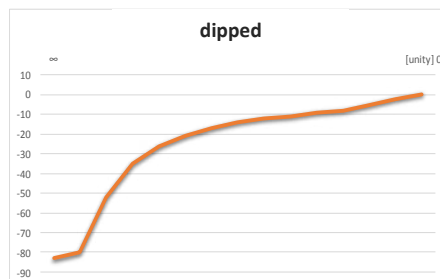
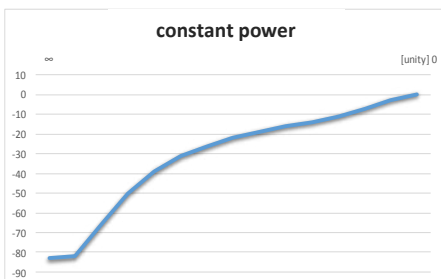

XFADER

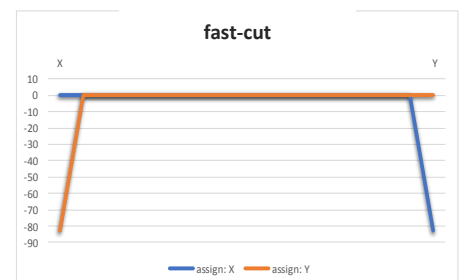
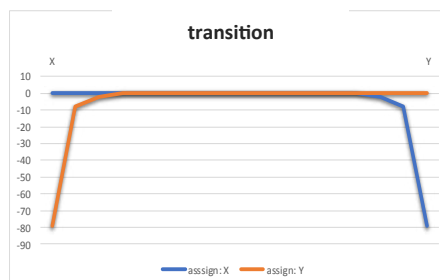

XONE:VCF SECTIONS, FILTER 1 - FILTER 2

11

XONE:VCF

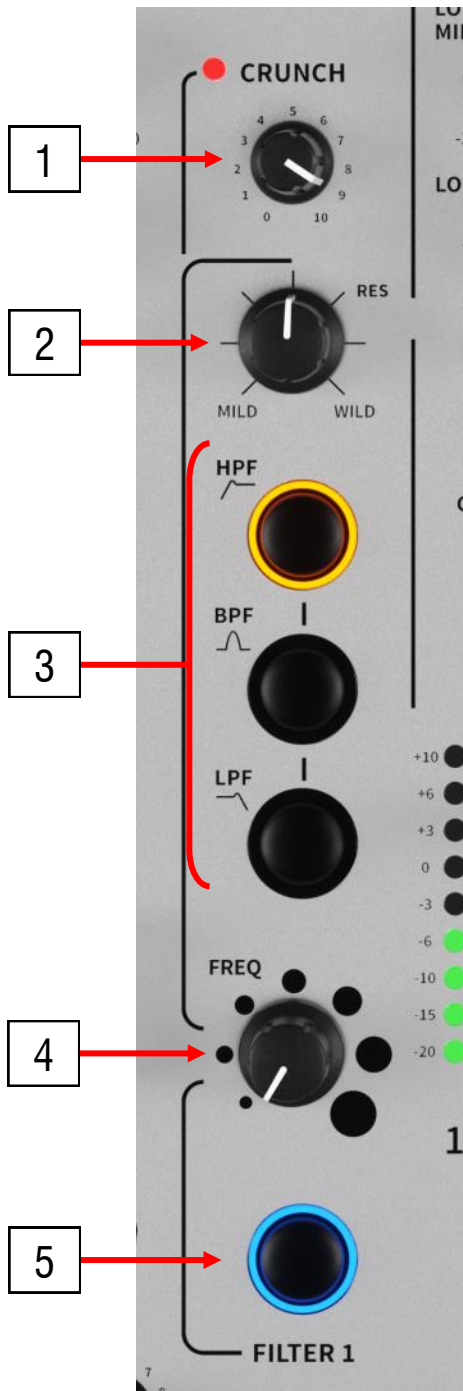

Nothing comes close to the sound and power of the XONE:VCF. XONE:96 refines this classic design, preserving the unmistakable sonic signature while taking its performance to the next level. Alongside the classic HPF, BPF, LPF, RES (MILD/WILD) and FREQ (sweep) control layout, we've added CRUNCH; controlled harmonic distortion that sits pre-FILTER in the circuit to give a powerful new effect. XONE:96 lets you route all six main channels to FILTER 1 or 2.

1 CRUNCH Control

Turn clockwise to add harmonic distortion (CRUNCH!) into the pre-FILTER signal path. Set to 0 the audio is clean and the LED is unlit. Set to 10 the signal distorts dramatically and LED illuminates RED. Use FILTER controls and switches to tune the post-FILTER output. For optimum CRUNCH system drive, maintain VCF assigned channel levels between +/-6dB

2 RES Resonance Control

Produces the classic XONE:VCF filter sound by feeding some of the filter output back to its input. The control ranges from MILD, with very subtle effect, to WILD, producing dramatic phase effects with feedback just short of self-oscillation.

3 HPF/BPF/LPF, Filter Type Select Switches

Set the output for FILTER 1 or FILTER 2. HPF selects the High Pass Filter (bass cut) slope. BPF selects the Band Pass Filter (bell shaped) response. LPF selects the Low Pass Filter (treble cut) slope. See XONE:VCF REFERENCE for details.

4 FREQ Frequency Sweep Control

This control sets the -3dB cut-off frequency of the VCF. It ranges from very low frequency (20Hz) when anti-clockwise, to very high frequency (20kHz) when turned fully clockwise.

5 FILTER ON/OFF Switch

Each VCF has its own ON switch. The switch illuminates BLUE when the FILTER is ON. The signal is not affected by the FILTER if set OFF. FILTER 1 and FILTER 2 ON/OFF switches are also enabled for MIDI control. See below

MIDI Control

- All Filter Type Select and FILTER ON/OFF switches send MIDI NOTE ON/OFF messages to the rear panel MIDI OUT port, and to USB 1 and USB 2 ports when the corresponding MIDI 1/ 2 switch is active.
- All Filter Type Select and FILTER ON/OFF switches can also be remotely controlled by MIDI output via USB 1 and USB 2. See p.28 for details

NOTE: XONE:VCF switches are also used for selecting the XONE:96 MIDI channel option. See p.28.

XONE:VCF REFERENCE

The XONE:VCF Voltage Controlled Filter

A Voltage Controlled Filter is an audio filter where the cut-off frequency is altered by DC control voltage rather than a variable resistor. This produces a much wider operating range and enables more control over the filter response for creating unlimited combinations of tonal effect.

Two stereo VCFs are provided, one either side of the crossfader, each with independent Filter Type Select (HPF, BPF, LPF), FREQUENCY sweep, RESonance and CRUNCH controls. These large soft touch controls are positioned either side of the crossfader and main mix channels 1 - 4 for convenient live operation.

Filter Type Select

The filters are 'state variable'. This means they provide three simultaneous filter response output types: High-Pass (HPF), Band-Pass (BPF) and Low-Pass (LPF). Three large illuminated switches select which type is active. Any combination can be pressed together to create different response types such as 'notch' and interesting 'all-pass' effects. Pressing one switch automatically deselects the previously active type.

All XONE:VCF switch controls implement fully redesigned analogue soft-switching for enhanced performance ensuring LR MIX outputs are unaffected by audible electronic artefacts as FILTER 1 and FILTER 2 are turned ON or OFF, when selecting different Filter Types, or if channel assignments to the VCFs are hot-switched.

- **NOTE:** the last selected XONE:VCF response is saved when mains power to the mixer is turned OFF.

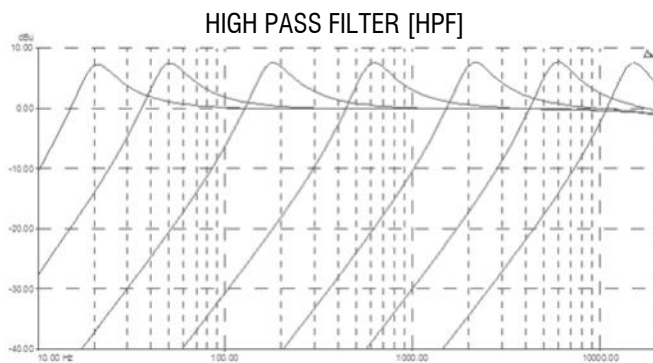

The graphs to the left illustrate effects on the audio frequency response for the three filter types. The range of sweep from low to high frequency is shown together with the effect of adjusting the RES control fully clockwise, to WILD.

The vertical scale shows the amount of boost around the normal 0dB operating level. The horizontal scale shows the change in frequency from low (sub-bass) to high (treble).

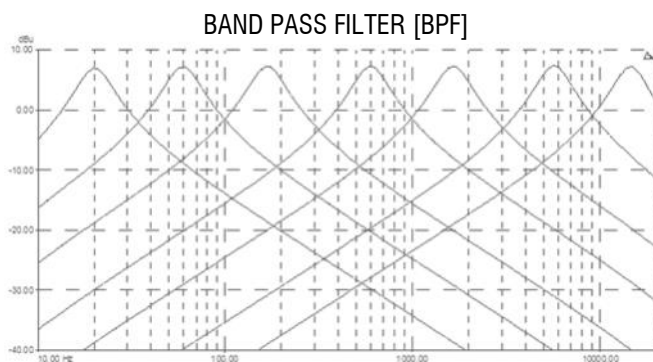

The graph below shows effects on frequency response for the Low Pass Filter [LPF] swept to @20Hz, 1kHz and 20kHz, together with the effect of adjusting the filter resonance to MILD, WILD and centred positions: one frequency with RES and FREQ set to minimum, 12 o'clock, and max.

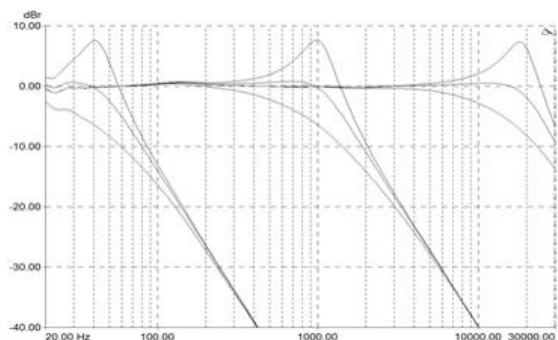
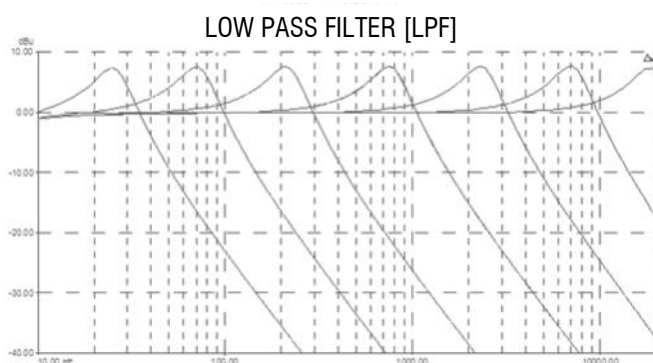

AUXILIARY RETURN CHANNELS C - D

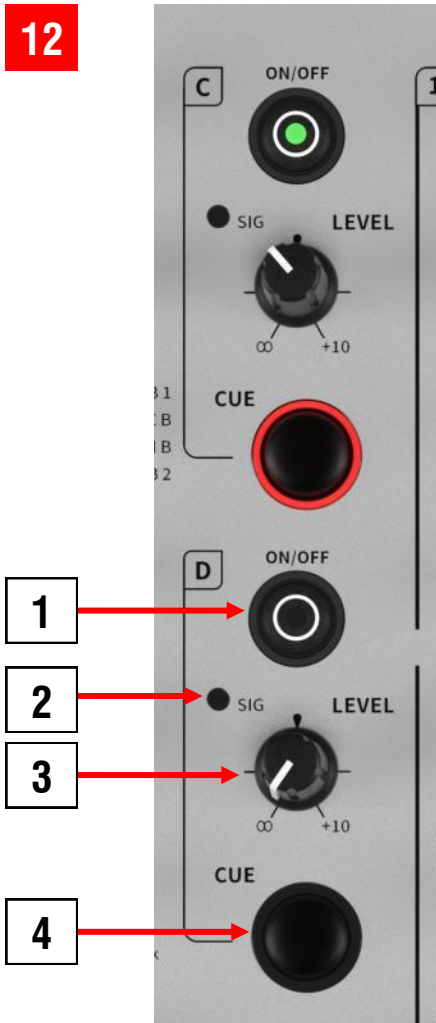

1 Channel ON/OFF Switch
Route signals from hardware connected via RTN C or RTN D inputs direct to the LR MIX at pre-MST levels. ON/OFF switches are enabled for MIDI control. See below.

2 SIG LED indicators
Bi-colour LEDs illuminate GREEN to show an audio input is present. If a SIG LED illuminates RED continually, turn the corresponding LEVEL control down.

3 Channel LEVEL Control
Adjust the RTN C and RTN C input levels from fully off to +10dBu

4 Channel CUE Switch
Press to listen to the channel audio levels from MONITOR headphones outputs and to view pre-LR MIX levels on the main LR MIX meters. Switches illuminate RED when active. Default switch setting is AUTO-CUE. Refer to p.9 for details. CUE switches are also enabled for MIDI control. See below.

MIDI Control

- Channel ON/OFF and CUE switches send MIDI NOTE ON/OFF messages to the rear panel MIDI OUT port, and to USB 1 and USB 2 ports when the corresponding MIDI 1/ 2 switch is active.
- Channel ON/OFF and CUE switches can also be remotely controlled by MIDI output via USB 1 and USB 2. See p.28 for details

MASTER SECTION

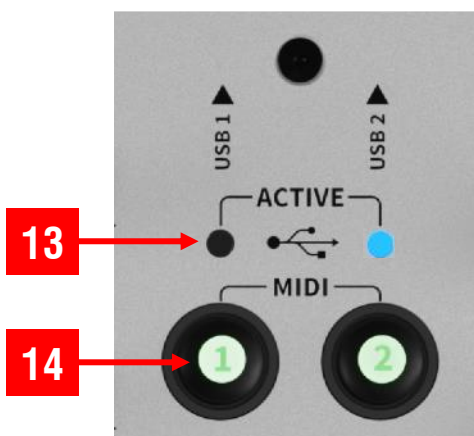

13 USB 1 / USB 2 Active Indicators
LED Illuminates BLUE when a computer connected to the mixer's corresponding USB 1 or USB 2 port is enabled.

14 MIDI 1 / 2 Switches
Switch the local XONE:96 MIDI output to the corresponding USB 1 or USB 2 ports ON / OFF. Switch status does not affect MIDI sent to the MIDI OUT port, via X:Link, or between USB 1 and USB 2 Partners.

MASTER SECTION continued

15

MIX/MONITOR Meters

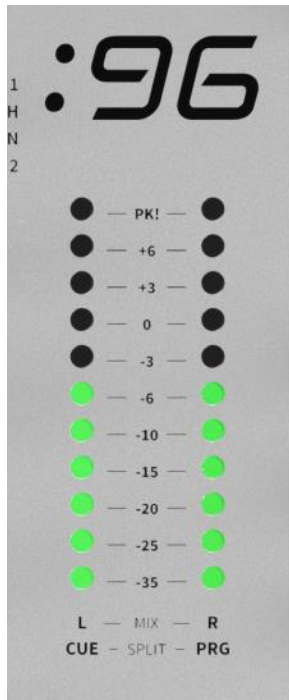

The main meters follow the selected monitor source.

The default display is LR MIX levels, which is overridden by an input channel level when any channel CUE switch is selected.

When CUE is active, the meters display the summed level of selected channels.

When CUE is inactive, meters display the LR MIX at pre-MASTER 1 control level.

In SPLIT CUE mode, the Left (L) meter displays active CUE channel levels and the Right (R) meter displays the main LR MIX level (PRG).

NOTE:

The mixer should be operated with meters averaging around 0 and loudest peaks at around +6.

If the **PK!** Indicators illuminate continually, ensure any GAIN or EQ settings are not causing clipping on Channel meters; if necessary, turn Channel GAIN, EQ, and/or FADERS *down* to prevent distortion on the main LR MIX.

Refer to the OPERATING LEVELS section on p.39 for information.

16



16

MASTER MIX Level Controls, MASTER 1/MASTER 2

Independent MASTER 1 and MASTER 2 controls to adjust levels for the main LR MIX, feeding MST 1 (XLR) and MST 2 (1/4" Jack) outputs.

MASTER 1 and MASTER 2 adjustment does not affect the LR MIX meter display, or RECORD, BOOTH, MONITOR or PHONES 2 levels.

17

17

USB 11/12 Source Select Switch

Selects the signal source routed to internal soundcard input channels USB 11/12 between MST (LR-MIX), or SEND 2.

PHONES 2 SECTION

21

XONE:96 features two independent cue systems for back-to-back sessions and smooth set transitions.



PHONES 2

Provides dedicated 9-way source select switch, CUE/MST mix and LEVEL controls, with stereo 1/4" Jack and 3.5mm mini-jack front-panel connectors.

PHONES 2 settings do not affect channel CUE assignments, or BOOTH and MONITOR outputs.

BOOTH & MONITOR SECTIONS

18 BOOTH

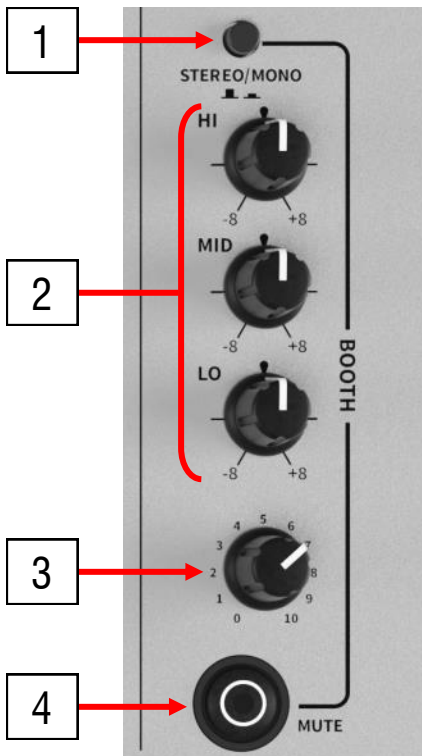

1

STEREO/MONO Switch

Enables LEFT and RIGHT monitor signals to be summed together so a selected stereo source can be checked for mono compatibility, especially important in club or recording applications. A drop in level or loss of low frequencies when pressed indicates reversed polarity between LEFT & RIGHT signals. Alternatively, select if you wish to run the booth monitor output in mono rather than stereo.

This does not affect MST, MONITOR or PHONES 2 outputs.

2

BOOTH Equaliser

Independent 3-Band EQ to tune the DJ's monitor speakers. Adjustment does not affect MST, MONITOR, or PHONES 2

3

Level Control

Adjusts level of the signal to the rear panel BOOTH outputs. This does not affect MONITOR or PHONES 2 outputs.

4

MUTE Switch

Press to mute signal to the BOOTH outputs.

The button illuminates RED when active.

Does not affect MST, MONITOR or PHONES 2 outputs.

The switch is also enabled for MIDI control. See p.28.

20 MONITORS

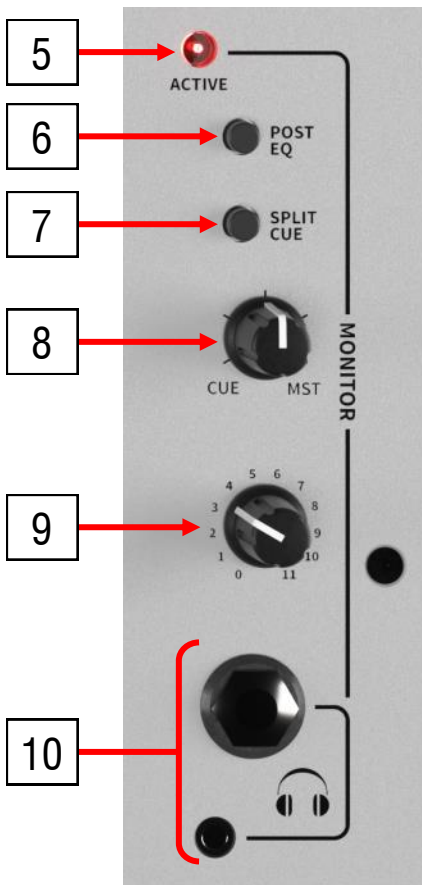

5

Cue ACTIVE Indicator

Illuminates RED when one or more CUE switch is enabled.

6

POST EQ Switch

Switch global channel CUE source between pre & post-EQ.

7

SPLIT CUE Switch

Enables CUE channel signals to route to the Left side of the MONITOR headphones and the LR MIX to the Right. Main meters display corresponding, CUE/PRG, levels when active.

8

CUE/MST Mix Control

Allows the main LR MIX output to be blended with the CUE signal. Turned fully anti-clockwise, only active CUE Channels are routed to the MONITOR headphones. Gradually turning the control clockwise introduces the LR MIX output to the headphones together with active CUE.

Selecting SPLIT CUE overrides the CUE/MST mix control.

9

Level Control

Adjusts the level of audio in MONITOR headphone outputs. This does not affect the BOOTH or PHONES 2 levels.

10

Headphone Outputs

Stereo 1/4" TRS jack and 3.5mm mini-jack sockets.

Plug in good quality stereo headphones designed for DJ monitoring. Use closed-ear headphones to provide the maximum acoustic isolation when cueing your sources.

SETUP EXAMPLES

CLASSIC : VINYL & MEDIA PLAYER (RCA) / EXT FX (SND-RTN) / MIC B (XLR)

- PHONO (RCA)
- LINE (RCA)
- SND 1 / RTN A (1/4" JACK)
- MIC B (XLR)

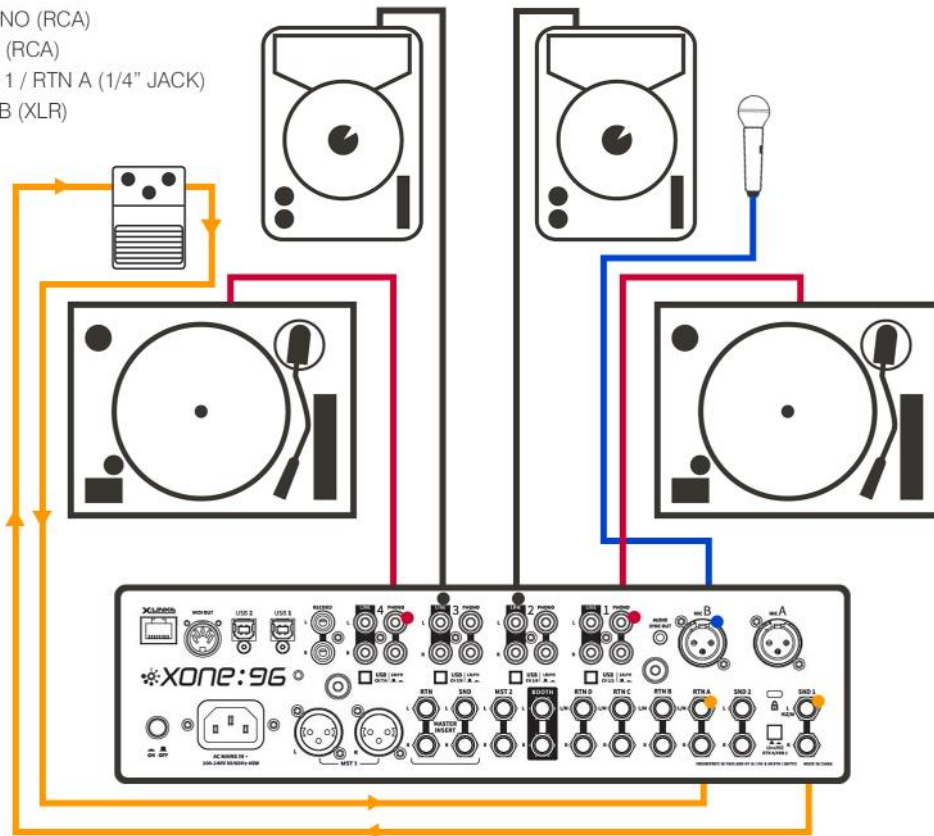

DIGITAL : VINYL & MEDIA PLAYER (DVS) / LAPTOP (USB 1 + USB 2) / X:LINK

- PHONO (RCA)
- USB1/2 (USB-B)
- LINE (RCA)
- X:LINK (RJ45)

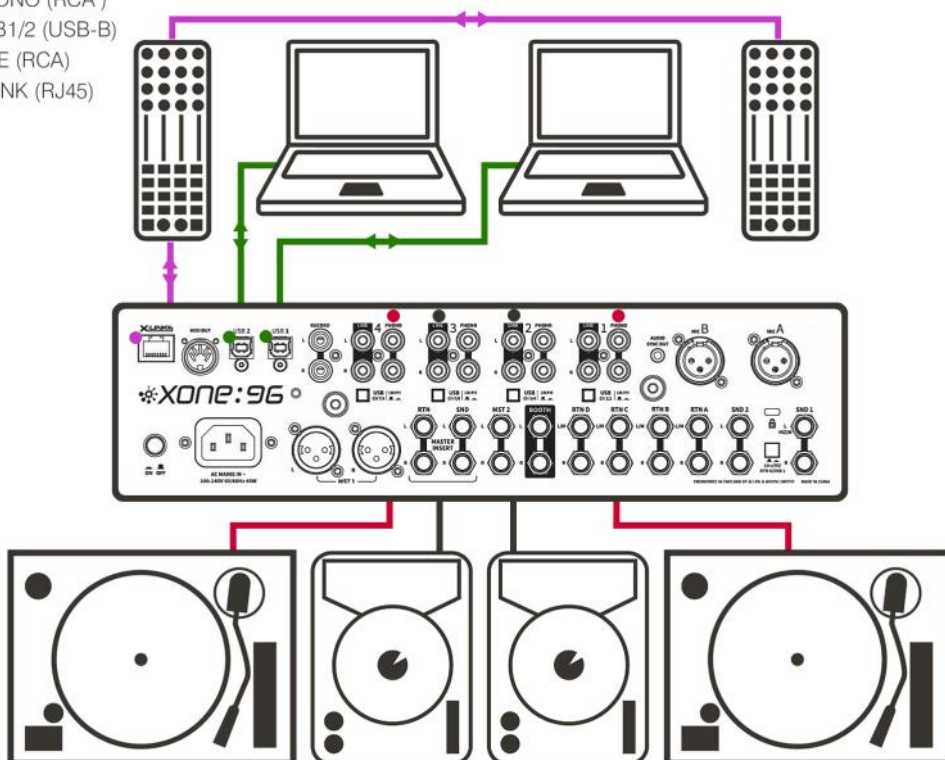

SETUP EXAMPLES

SND & RTN : EFFECTS & AUXILIARY DEVICE CONNECTIONS

- SND 1 / RTN A (1/4" JACK)
- SND 2 / RTN C (1/4" JACK)
- RTN B (1/4" JACK)
- RTN D (1/4" JACK)
- MIDI OUT (5 PIN DIN)
- USB 1 / 2 (USB-B)
- X:LINK (RJ45)
- INS SND (1/4" JACK)
- INS RTN (1/4" JACK)

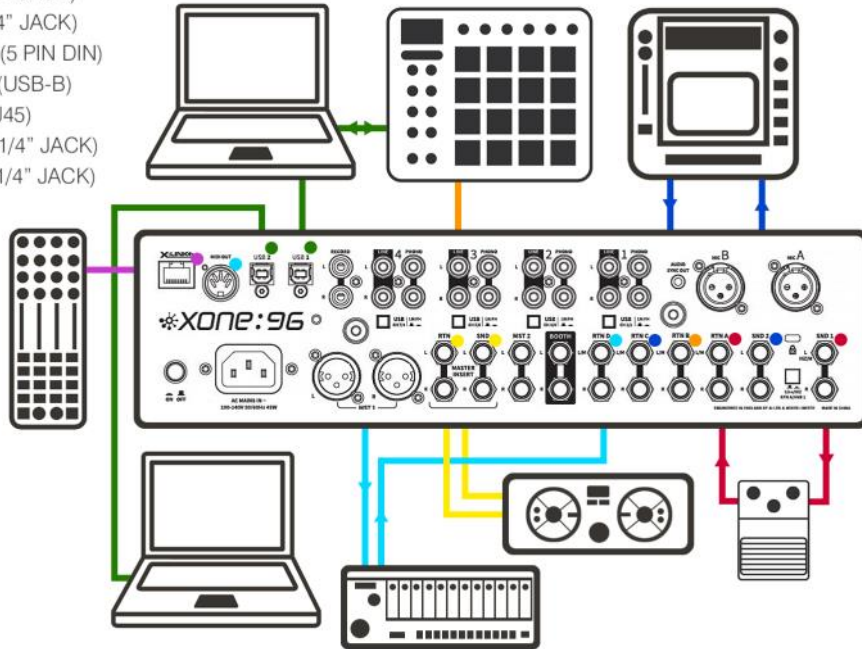

OUTPUT CONNECTIONS

- MST 1 (XLR)
- MST 2 (1/4" JACK)
- BOOTH (1/4" JACK)
- INS SND (1/4" JACK)
- INS RTN (1/4" JACK)
- REC (RCA)
- SYNC (MINI-JACK)

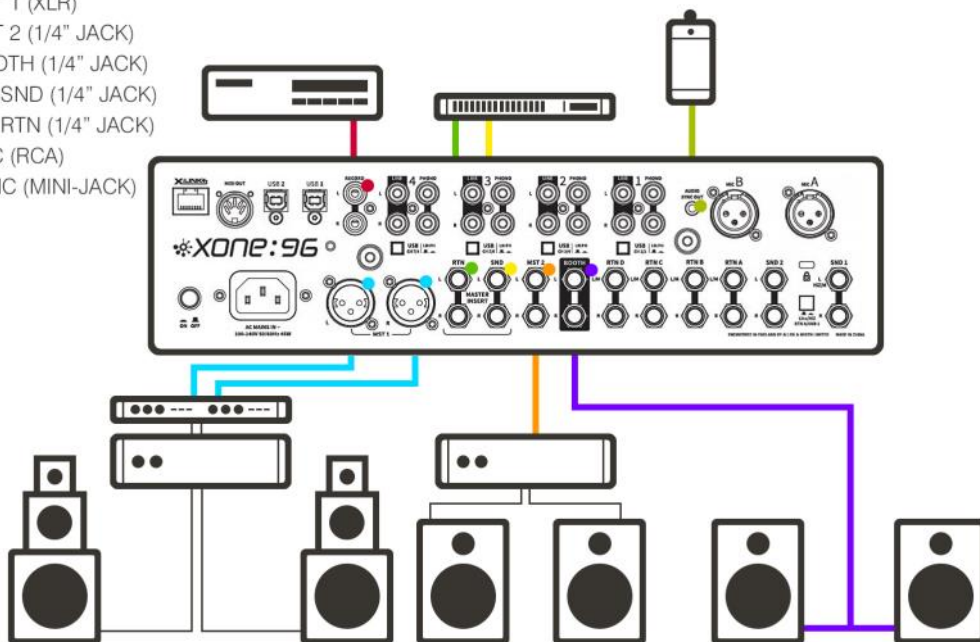

REAR PANEL OVERVIEW

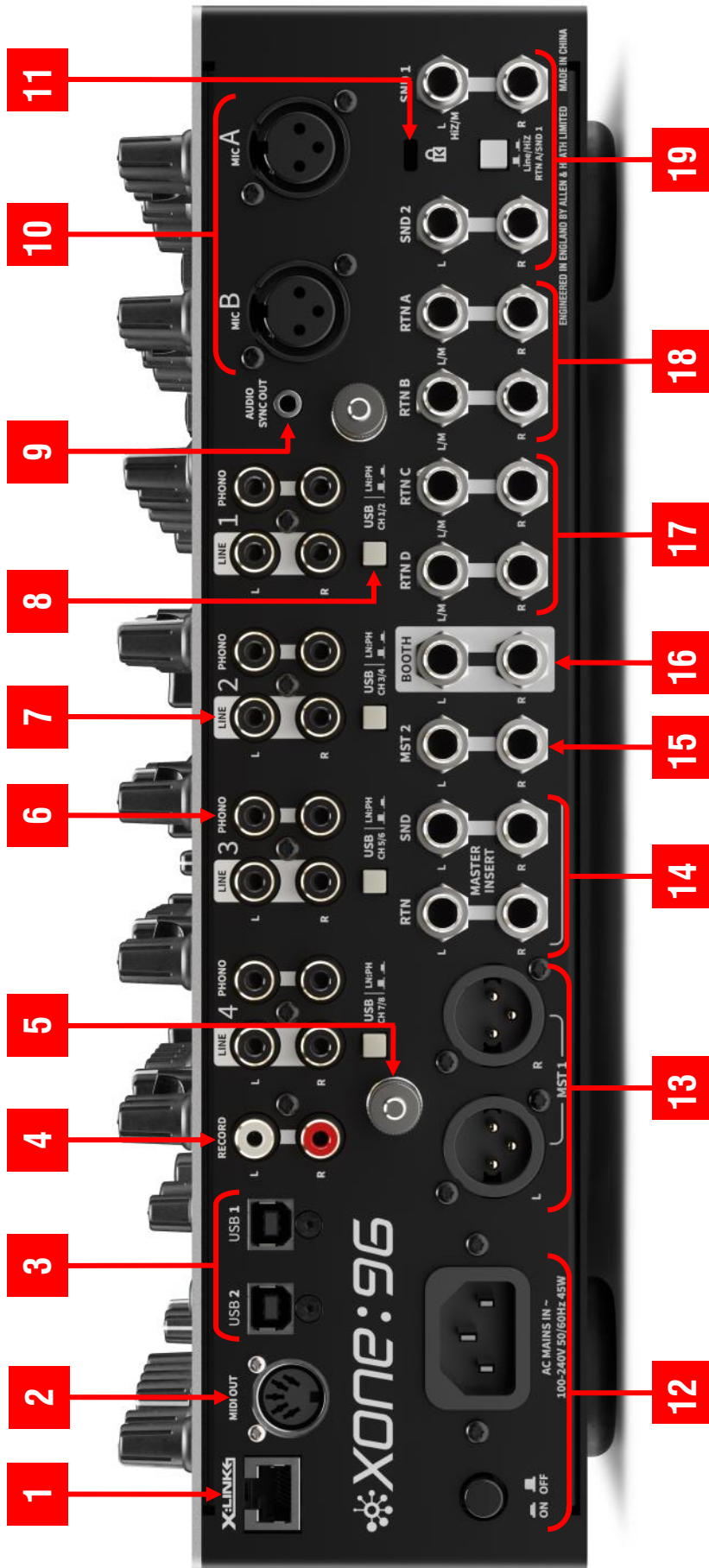

REAR PANEL CONNECTORS

Total Connectivity

XONE:96's rear panel is fully-loaded with I/O. Alongside all the analogue connections you'd expect to find, DJs will welcome the addition of dual-soundcards, 2 stereo sends, 4 stereo returns and dedicated master insert. SND/RTN A is switchable between Line and Hi-Z levels, making it ideal for incorporating instrument level effects, like classic guitar pedals, or legacy outboard hardware.

X-Link allows you to hook up XONE:K series controllers to the XONE:96 for hands-on control over your software, saving USB ports on your laptop.

MIDI Output to external hardware is catered for via the 5-pin connection on the rear panel, and to computers via USB 1 and USB 2 ports.

1

X:Link

Connect XONE:K Series Controllers to the XONE:96 mixer for remote software MIDI control and to save using USB ports on your computer.
RJ-45, Ethernet.

2

MIDI OUT

MIDI signal output from XONE:96, USB 1, USB 2, or X:LINK for syncing to external MIDI hardware.
5-pin DIN.

3

USB 1 and USB 2 Soundcards

Dual 24 Channel (6 Stereo IN/6 Stereo OUT), 32Bit/96kHz, internal Hi-Speed USB soundcards. macOS class compliant. ASIO* compatible. Direct, full-duplex, USB 1/USB 2 MIDI connection. See p.23-36.
USB-B.

4

RECORD Outputs

Pre-MASTER (MST) level, LR MIX output for connection to external hardware recording devices
Unbalanced RCA.

5

Chassis Earth Terminals

2 screw terminals are provided for connecting the earth straps from turntables to prevent ground hum.

6

PHONO Inputs, CH 1 - 4

Connect turntables with magnetic cartridges requiring RIAA equalisation to PHONO inputs.
For non-RIAA turntables plug into the LINE input instead.
Unbalanced RCA.

7

LINE Inputs, CH 1 - 4

Connect stereo LINE level media players to the LINE inputs. Do not connect turntables requiring RIAA equalisation. You can also connect to LINE level jack sources using RCA to jack adapter/cables.
Unbalanced RCA.

8

USB LINE / PHONO Select Switches, CH 1 - 4

Set CH1 - 4 USB 1 and USB 2 sources to LN or PH for LINE or RIAA signal level input to internal soundcards. For DVS (CD/Vinyl timecode) control, or recording CH1 - 4 inputs via USB 1 or USB 2.

9

Audio Sync Out

Enables future ALLEN&HEATH accessories to be easily connected to the XONE:96.
Alternative secondary Record Out; pre-MASTER level, LR MIX output to external devices.
Stereo 3.5mm mini-jack.

*ASIO is a trademark and software of Steinberg Media Technologies GmbH

REAR PANEL CONNECTORS continued

10 MIC A / MIC B Inputs

Use superior quality low impedance dynamic mics. Do NOT use high impedance or unbalanced mics, or condenser mics requiring phantom power.

NOTE: XONE:96 implements a 'clean feed' bus for MIC inputs; by default MIC A and MIC B inputs do not route to the BOOTH outputs and are unaffected by MASTER INSERT hardware processing.

Balanced XLR, wired; Pin1=Ground, Pin2=Hot [+], Pin3=Cold [-]

11 K-Slot

Security slot to connect locking, Kensington® type, anti-theft cable.

12 AC Mains Input

Connect (supplied) IEC cable with moulded plug compatible to local AC mains supply.

Turn AC supply to the mixer ON/OFF.

13 MST 1, MASTER Outputs

Main stereo LR MIX outputs that feed the club PA system, or active speakers.

Balanced XLR, wired; Pin1=Ground, Pin2=Hot [+], Pin3=Cold [-]

14 MASTER INSERT SND / RTN

Provides INSERT points for the MST1 outputs to connect hardware dynamics processors such as a limiter, compressor, or graphic equaliser. Or when connecting effects hardware in-line with the (MST1) LR MIX output for external MASTER INSERT FX. Insert devices do not affect MIC A/B inputs.

INSERT SND: Balanced (TRS) ¼" Jack, wired; Tip=Hot [+], Ring=Cold [-], Sleeve=Ground.

INSERT RTN: Unbalanced (MONO) ¼" Jack, wired; Tip=Hot [+], Sleeve=Ground.

15 MST 2 Outputs

Alternative stereo LR MIX output to feed additional zone, consumer amplifier, or active speakers.

Balanced (TRS) ¼" Jack, wired; Tip=Hot [+], Ring=Cold [-], Sleeve=Ground.

16 BOOTH Outputs

Dedicated, balanced LINE level stereo output feed to DJ's local monitor PA system, or active speakers.

Balanced (TRS) ¼" Jack, wired; Tip=Hot [+], Ring=Cold [-], Sleeve=Ground.

17 RTN C / RTN D, Auxiliary Return Inputs

Connect auxiliary LINE level music sources, or external effects outputs to route direct to LR MIX. Connect MONO devices via the L/M socket.

Use RTN C / RTN D top panel controls to adjust signal levels sent to the LR MIX.

Unbalanced (MONO) ¼" Jack, wired; Tip=Hot [+], Sleeve=Ground.

18 RTN A / RTN B, LINE Inputs

Connect auxiliary LINE level music sources, or external effects device outputs to RTN A and RTN B LINE inputs to route to CH A and CH B. Use L/M sockets when connecting MONO and Hi-Z devices.

Balanced (TRS) ¼" Jack, wired; Tip=Hot [+], Ring=Cold [-], Sleeve=Ground.

19 SND 1 / SND 2, LINE Outputs

Connect your external FX inputs to SND 1 or SND 2 outputs and use SEND 1 / SEND 2 controls to send Channel audio to the FX unit. Connect MONO devices via L/M.

Switchable SND 1 input and RTN A output impedance for external FX between LN, or Hi-Z suitable for guitar FX pedals or legacy hardware.

Balanced (TRS) ¼" Jack, wired; Tip=Hot [+], Ring=Cold [-], Sleeve=Ground.

DUAL INTERNAL SOUND CARD, USB 1 - USB 2

Unlock a world of creative possibilities. The XONE:96 features two Hi-Speed USB connections, each with six stereo inputs and outputs giving you a myriad of routing options.

State-of-the-art 96kHz/32-bit processing ensures the highest audio quality is passed between your laptops and the analogue engine.

USB1 and USB 2 operate independently, avoiding hassles for DJs who use different platforms, operating systems, or projects saved with different preferences, from collaborating live and in the studio.

XONE:96 soundcard channels are arranged in stereo pairs and will be displayed in your chosen Digital DJ, or DAW software, as follows:

USB AUDIO ROUTING		
Mixer Channel outputs <i>to</i> Computer [USB1 and USB2]		
Soundcard Input	XONE:96 Outputs	DAW Input
USB 1 / USB 2_1	CH1 L (RIAA or LINE)	Ch 1 L
USB 1 / USB 2_2	CH1 R (RIAA or LINE)	Ch 1 R
USB 1 / USB 2_3	CH2 L (RIAA or LINE)	Ch 2 L
USB 1 / USB 2_4	CH2 R (RIAA or LINE)	Ch 2 R
USB 1 / USB 2_5	CH3 L (RIAA or LINE)	Ch 3 L
USB 1 / USB 2_6	CH3 R (RIAA or LINE)	Ch 3 R
USB 1 / USB 2_7	CH4 L (RIAA or LINE)	Ch 4 L
USB 1 / USB 2_8	CH4 R (RIAA or LINE)	Ch 4 R
USB 1 / USB 2_9	SEND 1 L (PRE or POST)	Send 1 L
USB 1 / USB 2_10	SEND 1 R (PRE or POST)	Send 1 R
USB 1 / USB 2_11	SEND 2 L or MST L	Send 2 L / MST L
USB 1 / USB 2_12	SEND 2 R or MST R	Send 2 R / MST R
Mixer Channel inputs <i>from</i> Computer [USB1 or USB2]		
Soundcard Output	XONE:96 Inputs	DAW Output
USB 1 / USB 2_1	CH 1 USB 1 or USB 2_L	Ch 1 L
USB 1 / USB 2_2	CH 1 USB 1 or USB 2_R	Ch 1 R
USB 1 / USB 2_3	CH 2 USB 1 or USB 2_L	Ch 2 L
USB 1 / USB 2_4	CH 2 USB 1 or USB 2_R	Ch 2 R
USB 1 / USB 2_5	CH 3 USB 1 or USB 2_L	Ch 3 L
USB 1 / USB 2_6	CH 3 USB 1 or USB 2_R	Ch 3 R
USB 1 / USB 2_7	CH 4 USB 1 or USB 2_L	Ch 4 L
USB 1 / USB 2_8	CH 4 USB 1 or USB 2_R	Ch 4 R
USB 1 / USB 2_9	CHA USB 1 or USB 2_L	Ch A L
USB 1 / USB 2_10	CHA USB 1 or USB 2_R	Ch A R
USB 1 / USB 2_11	CHB USB 1 or USB 2_L	Ch B L
USB 1 / USB 2_12	CHB USB 1 or USB 2_R	Ch B R

For full details of the Dual-USB Soundcard Digital Architecture Specifications, please refer to p.35-36

XONE:96 is also fully **Traktor Scratch Certified** so the internal soundcards bring support for DVS control of Native Instruments' flagship [TRAKTOR SCRATCH PRO](#) DJ software straight out of the box.

Refer to p.30 for more details, or visit the [Native Instruments](#) website.



DRIVER INSTALLATION (PC)

Installing XONE:96 Soundcard Device Drivers

Apple macOS

The XONE:96 is an Apple Mac CoreAudio and CoreMIDI class compliant interface and works on macOS platforms without any requirement to install hardware device drivers. Refer to p.26 for details to confirm that the interface and computer are fully connected before opening your Digital DJ, or DAW application.

Microsoft Windows® PC

In order to access the soundcard channels on your XONE:96 you will need to install the dedicated, ASIO* compatible, Device Drivers, which can be downloaded from the Allen & Heath website:

www.allen-heath.com/xone96



PLEASE FOLLOW INSTALL INSTRUCTIONS CAREFULLY

NOTE:

- Please ensure you are logged on to the PC with Administrator access enabled
- When the driver package has downloaded, extract the installer to your computer desktop. Follow the on-screen instructions as detailed below:
The installer will also prompt you through the steps necessary to install this software.
- Double-click on the **XONE:96 Driver Setup** file to begin.

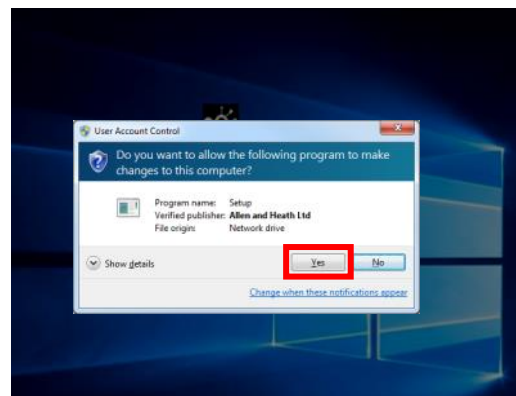

- Click **Yes** on the User Account Control prompt to confirm and continue installation.

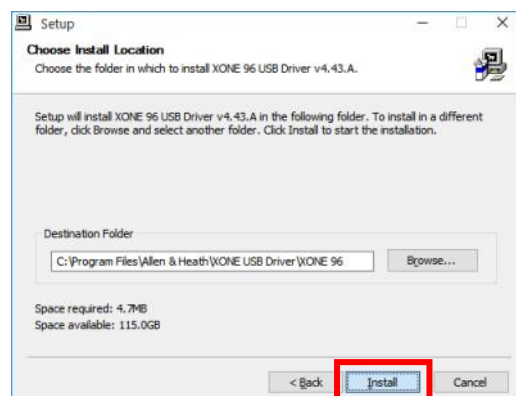

- Click **Next** to run the installer application.
- Click on the **Install** tab to pre-install the Device Drivers to the default system folder.

A series of messages will be displayed...

*ASIO is a trademark and software of Steinberg Media Technologies GmbH

DRIVER INSTALLATION (PC) continued

- This may take some time to complete.
- Please wait while XONE:96 v4.43.0 software is installed...

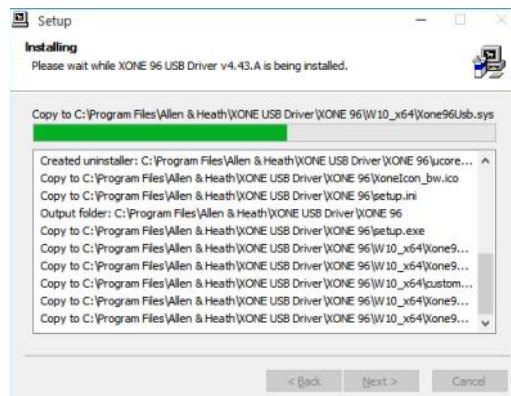
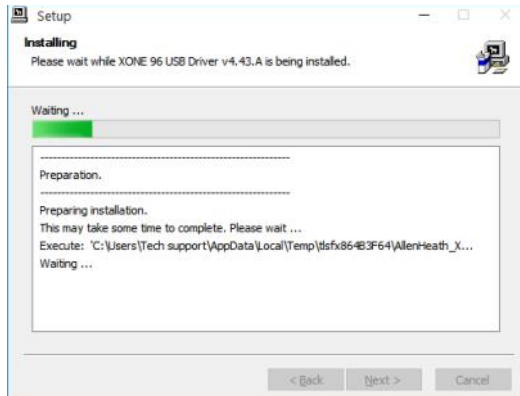

- Click **Install** if prompted to install *Allen&Heath Sound, video and game controllers* software.
- Click **Install** if prompted to install *Allen&Heath XONE:96 Audio Devices* software.

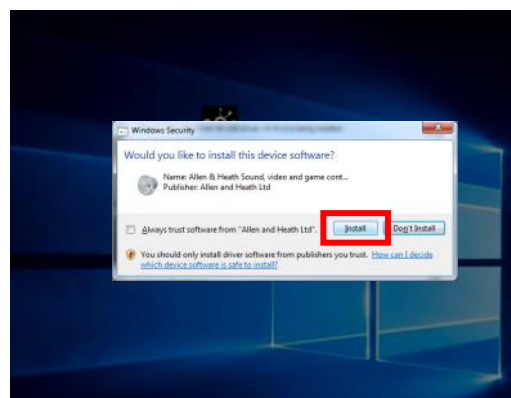
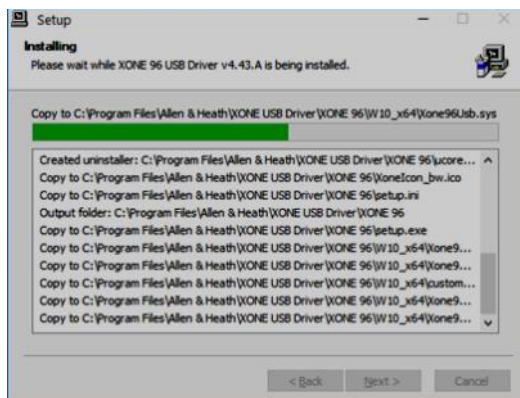

- Connect the XONE:96 mixer to your PC via the USB 1, or USB 2 port and power the unit **ON***

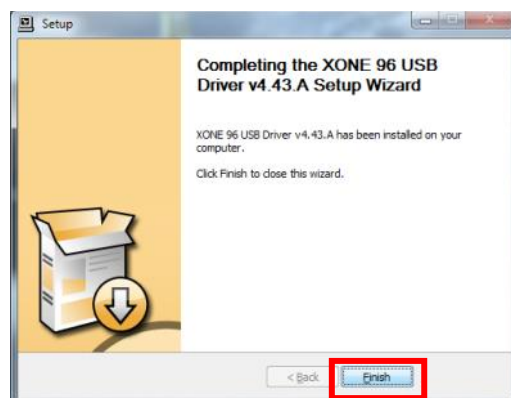
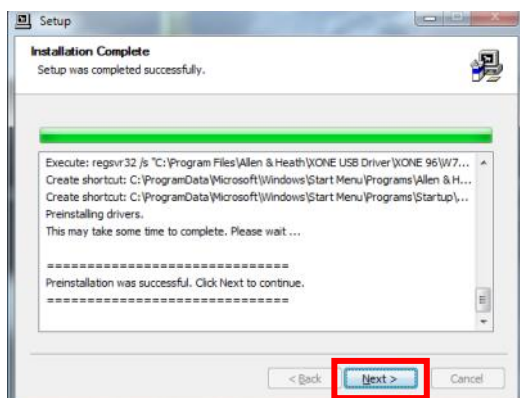

- Click **Next** to continue once the pre-installation process has completed.
- Click **Finish** to complete the Device Driver installation.

NOTE:

It is possible to run the XONE:96 Device Driver pre-installation process without connecting the XONE:96 mixer to your computer.

In this case you will be prompted to “...disconnect and reconnect the device to complete driver installation.”

If the mixer cannot be connected, click **Yes** on the prompt to close the application.

To complete installation, connect the XONE:96 to your PC via USB, power the mixer **ON**.

Wait a few moments for the PC to enumerate the mixer before opening your software application.

DEVICE CHECKS (Mac and PC)

When first connecting the XONE:96 to a Mac or PC computer, check the interface is being recognised correctly by the system as follows, before opening your Digital DJ, or DAW software:

Apple macOS

- Connect the XONE:96 to your Mac via USB 1 or USB 2;
The corresponding USB ACTIVE indicator illuminates BLUE when the mixer is powered ON.
- On the Mac, navigate to: *Finder / Applications / Utilities / Audio MIDI Setup*
- From the *Windows* menu, select; **Show Audio Devices**
- In the Input and Output sections, 12 channels should be seen as shown.

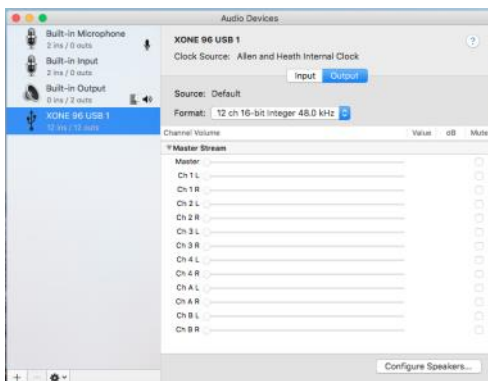

- The **Format:** menu displays the currently selected sample rate and bit depth
- Sample rate is selectable from 44.1 to 96kHz.
- Bit depth is selectable between 16bits and 32bits
- Device Settings should be adjusted as required to suit particular applications and the host system's CPU capacity.
See p.35 for details of supported buffer sizes.

- Next, select **Show MIDI Studio** and check the XONE:96 is displayed and highlighted as shown below.



Microsoft Windows PC

- Connect the XONE:96 to your PC via USB 1 or 2. The corresponding USB 1/ 2 ACTIVE indicator illuminates BLUE when the mixer is powered ON.
- On your PC, open the XONE 96 Control Panel
- Status view displays: XONE:96 USB 1 (or USB 2) and Current Sample Rate
- Format view Input and Output sections display: 12 channels and the currently selected bit depth.

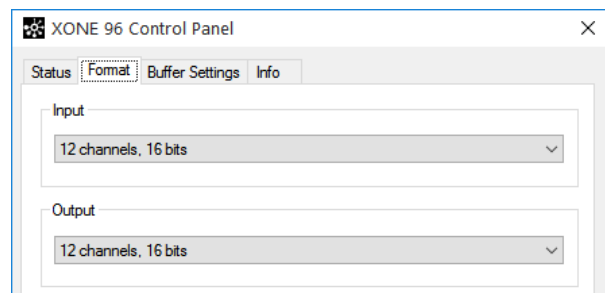

- Sample Rate is selectable from 44.1 to 96kHz.
- Bit depth is selectable between 16bits and 32bits
- Device Settings can be adjusted as required to suit applications or host system's CPU capacity.
See p.35 for details of supported buffer sizes.

- Next, navigate to:
START / Settings / Devices / Device Manager
- Expand **Audio inputs and outputs** to display;
Line (Xone:96 USB 1) and Speakers (Xone:96 USB 1)

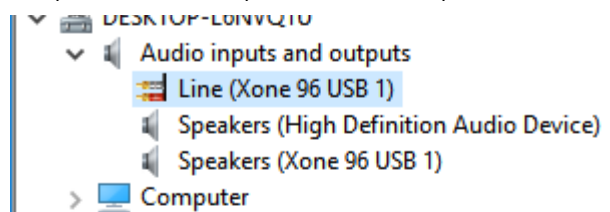

- Expand **Sound, Video and Game Controllers** and **XONE 96 Audio Devices** sections to display;

Xone:96 USB 1 or Xone:96 USB 2

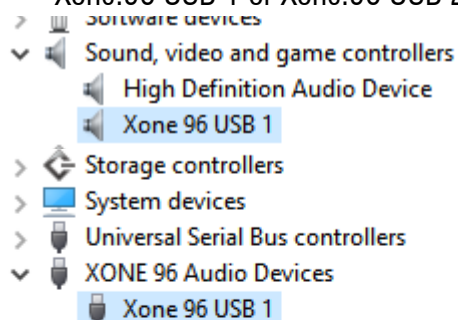

MIDI CONTROL

MIDI stands for **M**usical **I**nstrument **D**igital **I**nterface; a protocol established in the 1980s to enable different keyboards, sequencers, drum machines, etc. to communicate with each other. MIDI remains a common and popular means to enable remote control of functions within DJ performance, or DAW (Digital Audio Workstation) software.

XONE:96 has the ability to send and receive MIDI data, with a total of 31 MIDI enabled controls; 19 buttons, 5 faders and 7 rotary switches that can be assigned as controls for most Digital DJ and DAW applications.

Refer to the following colour coded image and tables for details of the MIDI controls, assignment values, and to convert between equivalent hexadecimal, decimal and chromatic scale values.

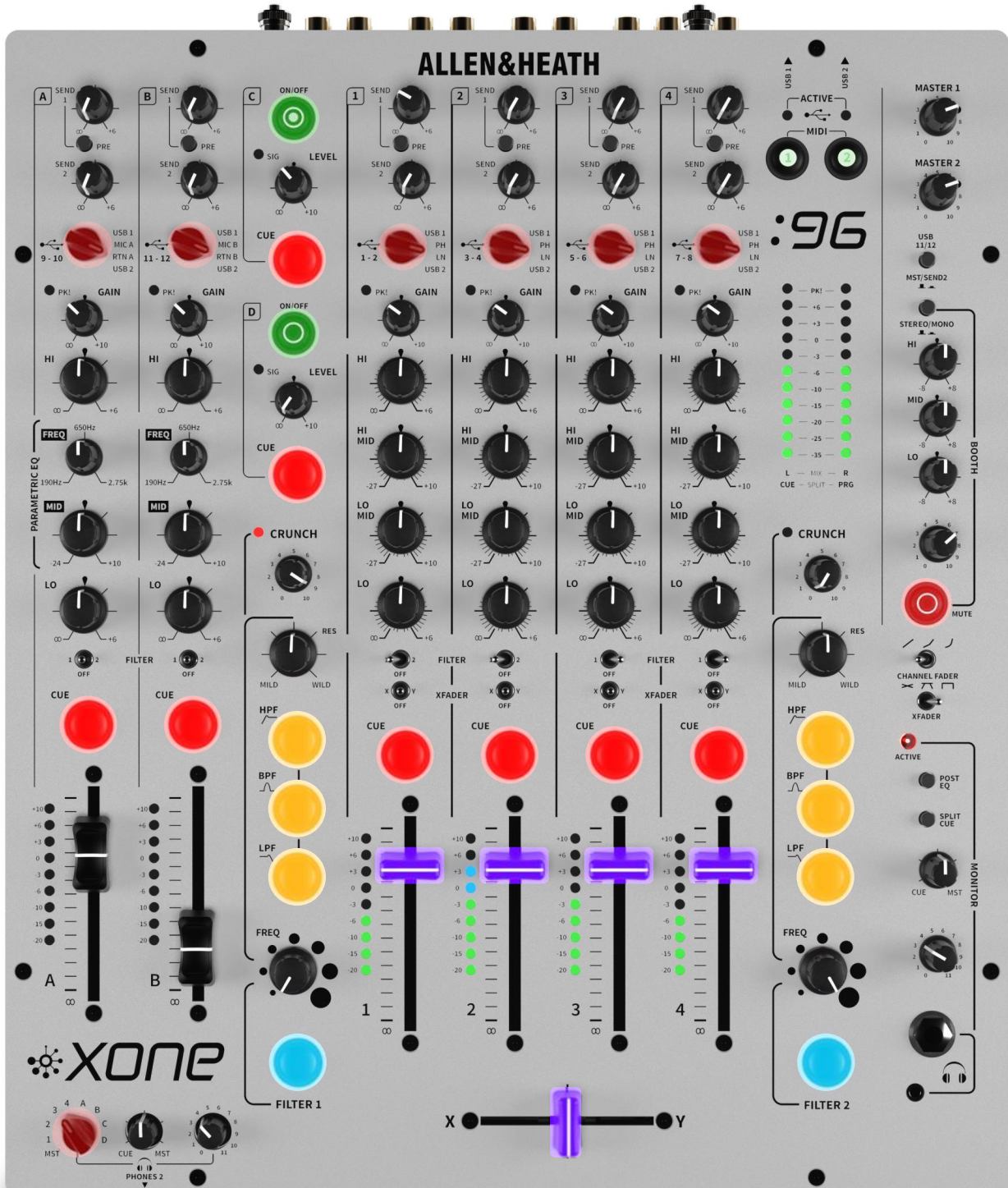

MIDI CONTROL continued

MIDI CONTROL VALUE [HEX]	XONE:96 CHANNEL												MIDI VALUES			
	1	2	3	4	A	B	C	D	VCF 1	VCF 2	LR MIX	MUTE	NOTE/CC	CH#	OUT	IN
CH SOURCE*	✓	✓	✓	✓	✓	✓	✗	✗	✗	✗	✗	✗	NOTE*	16	✓	✗
CH FADER	00	01	02	03	✗	✗	✗	✗	✗	✗	✗	✗	CC	16	✓	✗
CH CUE	00	01	02	03	04	05	06	07	✗	✗	✗	✗	NOTE	16	✓	✓
HPF	✗	✗	✗	✗	✗	✗	✗	✗	0A	0E	✗	✗	NOTE	16	✓	✓
BPF	✗	✗	✗	✗	✗	✗	✗	✗	0B	0F	✗	✗	NOTE	16	✓	✓
LPF	✗	✗	✗	✗	✗	✗	✗	✗	0C	10	✗	✗	NOTE	16	✓	✓
ON / OFF	✗	✗	✗	✗	✗	✗	08	09	0D	11	✗	12	NOTE	16	✓	✓
PHONES 2	2B	2C	2D	2E	2F	30	31	32	✗	✗	33	✗	NOTE	16	✓	✗
XFADER													05 CC	16	✓	✗
* CH IP SOURCE MIDI VALUES [HEX]																
USB 1	13	17	1B	1F	23	27							NOTE	16	✓	✗
PHONO	14	18	1C	20	✗	✗							NOTE	16	✓	✗
LINE	15	19	1D	21	✗	✗							NOTE	16	✓	✗
MIC A	✗	✗	✗	✗	24	✗							NOTE	16	✓	✗
MIC B	✗	✗	✗	✗	✗	28							NOTE	16	✓	✗
RTN A	✗	✗	✗	✗	25	✗							NOTE	16	✓	✗
RTN B	✗	✗	✗	✗	✗	29							NOTE	16	✓	✗
USB 2	16	1A	1E	22	26	2A							NOTE	16	✓	✗

MIDI Channel Setup

The default XONE:96 MIDI Channel is 16, but can be changed to any channel between 1 and 16 when powering the mixer ON. To change the channel number:

- Press and hold down both MIDI 1 and MIDI 2 switches
- Power the XONE:96 mixer ON
CH A/ B /1-4 CUE, and FILTER 1/ FILTER 2 HPF Filter Type Select switches blink slowly
- Press the corresponding CUE or HPF switch to select the required MIDI channel between 1 and 8*

NOTE: To access MIDI CH 9 - 16:

- Push the FILTER 1 or FILTER 2 ON/OFF switch once.
CH A/ B /1-4 CUE, and FILTER 1/FILTER 2 HPF Filter Type Select switches blink rapidly
- Press the corresponding CUE or HPF switch to select the required MIDI channel between 9 and 16*



CUE A = MIDI CH 1 or 9 | CUE B = MIDI CH 2 or 10 | F1 HPF = MIDI CH 3 or 11 | CUE 1 = MIDI CH 4 or 12
CUE 2 = MIDI CH 5 or 13 | CUE 3 = MIDI CH 6 or 14 | CUE 4 = MIDI CH 7 or 15 | F2 HPF = MIDI CH 8 or 16

- After the CUE or HPF switch is pressed, the switches stop blinking and Filter Type Select switch LEDs cascade to indicate the MIDI channel change is implemented.

NOTE: The new MIDI channel remains stored when the mixer is powered OFF and is recalled on subsequent power-cycles until any further change is made.

MIDI IMPLEMENTATION TABLES

OCTAVE	MIDI NOTE VALUES [NOTE OFF = 00 / NOTE ON = 7F]																								
	C	C# /Db	D	D# /Eb	E	F	F# /Gb	G	G# /Ab	A	A# /Bb	B													
-1	0	00	1	01	2	02	3	03	4	04	5	05	6	06	7	07	8	08	9	09	10	0A	11	0B	
0	12	0C	13	0D	14	0E	15	0F	16	10	17	11	18	12	19	13	20	14	15	16	17	18	19	1A	1B
1	24	18	25	19	26	1A	27	1B	28	1C	29	1D	30	1E	31	1F	32	20	33	21	34	22	35	23	
2	36	24	37	25	38	26	39	27	40	28	41	29	42	2A	43	2B	44	2C	45	2D	46	2E	47	2F	
3	48	30	49	31	50	32	51	33	52	34	53	35	54	36	55	37	56	38	57	39	58	3A	59	3B	
4	60	3C	61	3D	62	3E	63	3F	64	40	65	41	66	42	67	43	68	44	69	45	70	46	71	47	
5	72	48	73	49	74	4A	75	4B	76	4C	77	4D	78	4E	79	4F	80	50	81	51	82	52	83	53	
6	84	54	85	55	86	56	87	57	88	58	89	59	90	5A	91	5B	92	5C	93	5D	94	5E	95	5F	
7	96	60	97	61	98	62	99	63	100	64	101	65	102	66	103	67	104	68	105	69	106	6A	107	6B	
8	108	6C	109	6D	110	6E	111	6F	112	70	113	71	114	72	115	73	116	74	117	75	118	76	119	77	
9	120	78	121	79	122	7A	123	7B	124	7C	125	7D	126	7E	127	7F									
	DEC	HEX	DEC	HEX	DEC	HEX	DEC	HEX	DEC	HEX	DEC	HEX	DEC	HEX	DEC	HEX	DEC	HEX	DEC	HEX	DEC	HEX	DEC	HEX	

MIDI CONTROL CHANGE VALUES [min = 00 / max = 7F]																					
CC	0	1	2	3	4	5	6	7	8	9	10	11	12	13	14	15	16	17	18	19	20
HEX	00	01	02	03	04	05	06	07	08	09	0A	0B	0C	0D	0E	0F	10	11	12	13	14
NOTE	C-1	C#-1	D-1	D#-1	E-1	F-1	F#-1	G-1	G#-1	A-1	A#-1	B-1	C0	C#0	D0	D#0	E0	F0	F#0	G0	G#0
CC	21	22	23	24	25	26	27	28	29	30	31	32	33	34	35	36	37	38	39	40	41
HEX	15	16	17	18	19	1A	1B	1C	1D	1E	1F	20	21	22	23	24	25	26	27	28	29
NOTE	F0	F#0	G0	G#0	A0	A#0	B0	B#0	C1	C#1	D1	D#1	E1	F1	F#1	G-1	G#1	A1	A#1	B1	B#1

TIMECODE SETUP - TRAKTOR SCRATCH PRO

This section explains how to configure the XONE:96 DJ Mixer to control playback via timecode from an external turntable or CD player when using TRAKTOR SCRATCH PRO.

- Ensure TRAKTOR *SCRATCH PRO* is installed and activated on your computer
NOTE: TRAKTOR PRO 2 does not support timecode control.
- Ensure that your XONE:96 DJ Mixer is connected to the computer via USB 1 or USB 2.
- Connect turntables or CDJ media players to the LINE / PHONO Inputs on the XONE:96.
- Set the USB LN/PH switches on the XONE:96 rear panel for turntables or CDJ media players.
e.g. Switch *in* to **PH** for use with turntables. Switch *out* to **LN** for use with CDJ media players.



- Next, on the XONE:96 top panel; set corresponding CH1 - 4 Input Select Switches to USB 1 or USB 2.



- Next, in TRAKTOR SCRATCH PRO; open **Preferences**
- Select the **Audio Setup** dialogue
- Check, or select XONE 96 as the **Audio Device**
macOS: **XONE 96 USB 1**, or **XONE 96 USB 2** | Windows: **XONE 96 ASIO Driver***

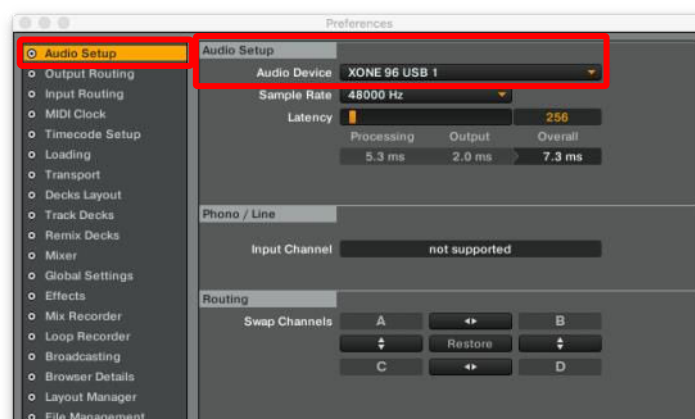

*ASIO is a trademark and software of Steinberg Media Technologies GmbH

TIMECODE SETUP continued

- Next, select the **Output Routing** dialogue
- Check, or select **Mixing Mode > External**.
- When connected, the XONE:96 internal soundcard routing for *input* channels 1 - 8 defaults as shown:
TRAKTOR Deck Layout: **C-A-B-D**

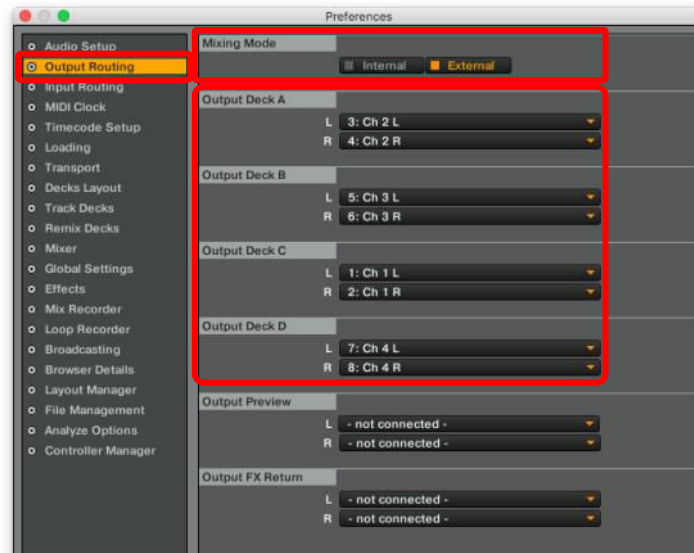

- Next, select the **Input Routing** dialogue
- When connected, XONE:96 internal soundcard *output* channels 1 - 8 defaults as shown;

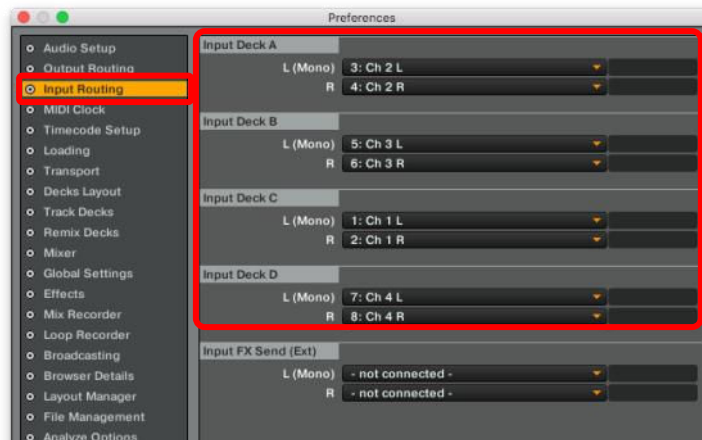

TRAKTOR Deck Layout: **C-A-B-D**



TIMECODE SETUP continued

- Select the **Timecode Setup** dialogue
- Change the **Timecode inputs** on the decks (A/B/C/D) from; Internal Playback to **Scratch Control**



- Select the **Decks Layout** dialogue
- In the **Platter / Scope** dialogue, choose **Scope** for the Decks you want to control with timecode.

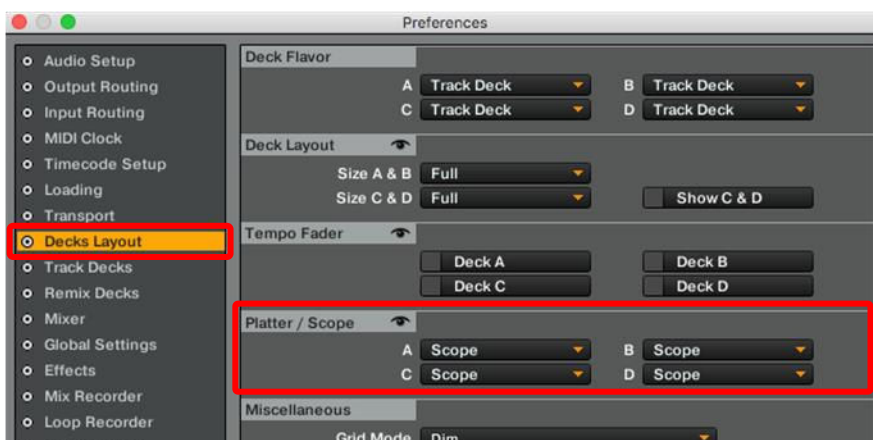

- **CALIBRATE** the deck/s on the scopes with the timecode source; Control CD, Control Vinyl, or WAV on a USB stick.



RECORDING A MIX - TRAKTOR SCRATCH PRO 2

- On the XONE:96 top panel, set the **USB 11/12 MST/SEND 2** switch *up* to: **MST**.



- In Traktor, select the **Input Routing** dialogue.
- Set an unused **Input (Deck, or FX Send (Ext))** to: **L (Mono)11: Send 2 L/MST L | R 12: Send 2 R/MST R**

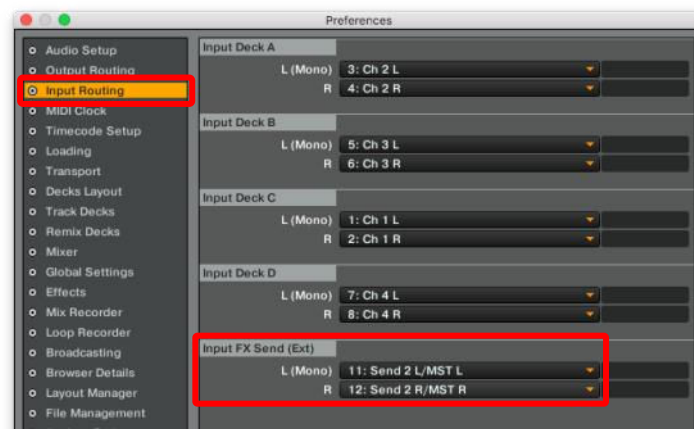

- Next, select the **Mix Recorder** dialogue.
- Set **Source** to: **External**.
- Set **External Input** to the corresponding **Input Deck**, or **Input FX Send (Ext)** assignment (as above).

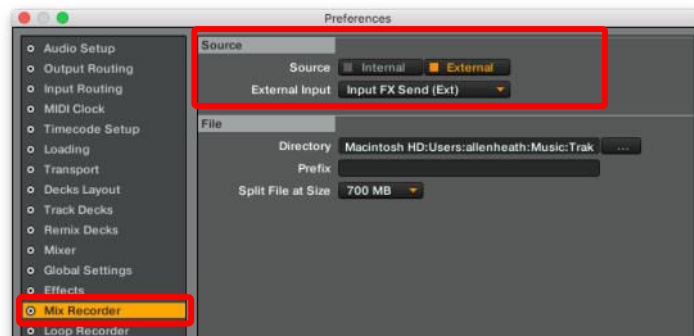

- Finally, go to the **Audio Recorder** in the main TRAKTOR screen, set your level and hit record.



BLOCK DIAGRAM

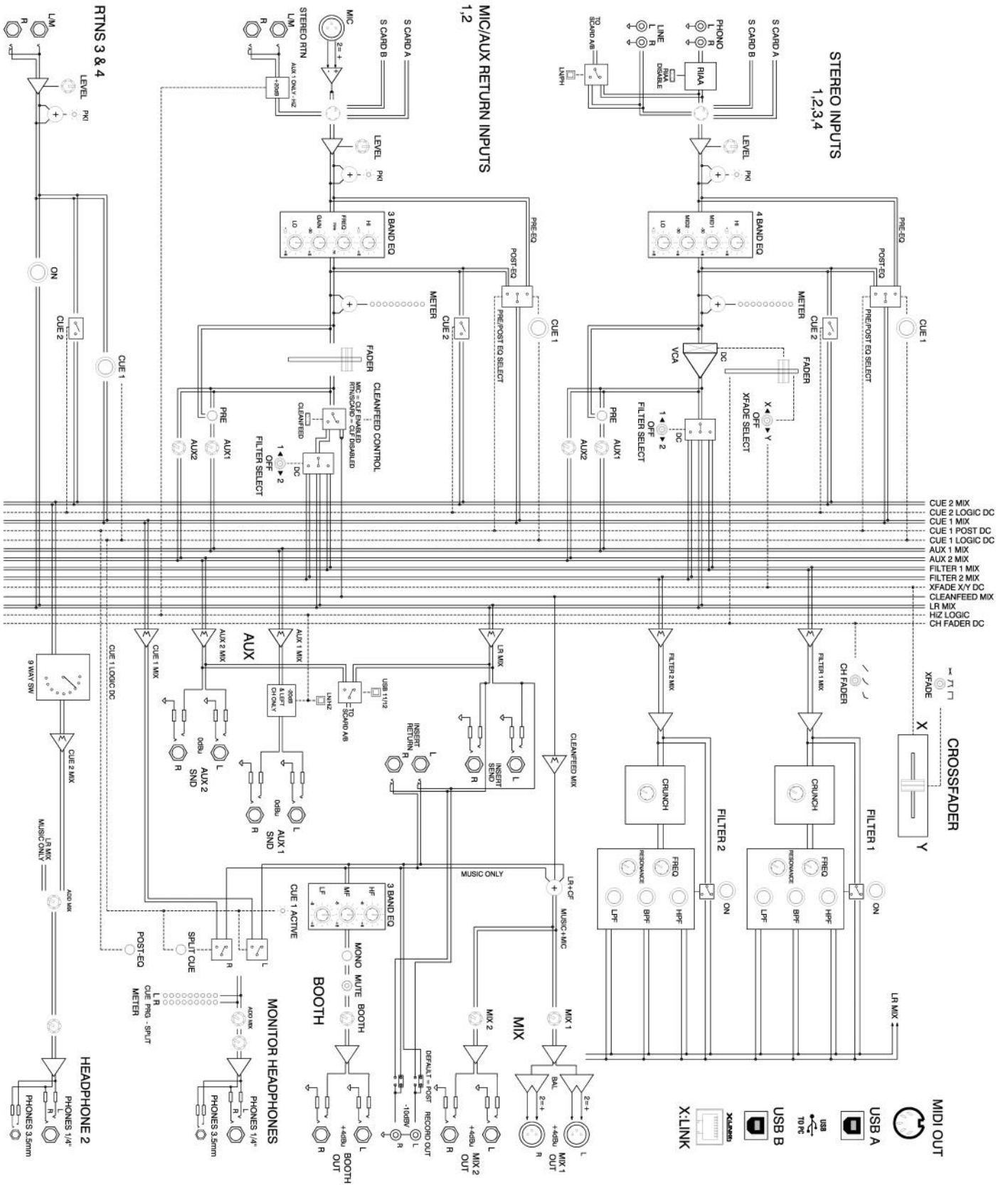

TECHNICAL SPECIFICATIONS

Hardware Specification

Output Levels; Nom (0VU) / Max	MASTER 1	+ 4dBu	/	+ 24dBu
	INSERT	- 2dBu		
	MASTER 2	+ 4dBu	/	+ 18dBu
	BOOTH	+ 4dBu	/	+ 18dBu
	RECORD	- 8dBu	/	+ 10dBu
Internal headroom	Channels	+ 20dB		
Frequency response	LINE IN to MST out	+/-0.5dB from 20Hz to 30kHz		
Distortion	Typically 0.03% @ 1kHz 0dBu (THD+Noise 22Hz to 22kHz)			
Crosstalk	< -85dB inter-channel @ 1kHz +10dBu			
Residual Noise (22Hz - 22kHz)	MASTER 1	- 98dBu		
	MASTER 2	- 98dBu		
	BOOTH	-101dBu		
Mix Noise (22Hz - 22kHz)	Master 1	- 90dBu		
	Master 2	- 85dBu		
	Booth	- 85dBu		
	Record RCA	- 90dBu		
Mic Gain	+40dB, EIN = -120dB (@ 40dB gain with 150R source)			
RIAA Gain	+42dB @ 1kHz (6mV RMS= 0VU @ 1kHz)			
Channel Meters	9 LED	- 20dBu	to	+ 10dBu
Master Meters	11 LED	- 35dBu	to	+ 10dBu
Channel EQ A/B	HI	3kHz		+ 6/-∞dB
	PARAMETRIC	190Hz - 2.75kHz		+10/-24dB
	LO	180Hz		+ 6/-∞dB
Channel EQ 1-4	HI	3kHz		+ 6/-∞dB
	HI MID	1.1kHz		+10/-27dB
	LO MID	350Hz		+10/-27dB
	LO	180Hz		+ 6/-∞dB
Channel faders 1-4	60mm VCA control individually replaceable. Plug in replacement - user replaceable [A&H spare-part#: 004-999X] < -85dB shutoff @1kHz +10dBu			
Cross-fader	45mm innoFADER VCA control. Plug in replacement - user replaceable [A&H spare-part#: AI11470]			
Filters	Dual, stereo, analogue Voltage Controlled Filters.			

Digital Architecture (USB) Specification

Analogue/Digital Line-up	0dBu = - 14dBFS
Audio Channels:	24 Channel (6 Stereo IN / 6 Stereo OUT),
Supported Variable Buffer Sizes:	32 / 64 / 128 / 256 / 512 / 1024 / 2048 / 4096 / 8192 samples
Supported Sample Rates:	44.1 kHz / 48kHz / 88.2kHz / 96kHz
Supported Bit depth:	16 bit / 32 bit
USB MIDI Channels:	2 x MIDI IN / 2 x MIDI OUT (USB 1 and USB 2)

SPECIFICATIONS continued

Model	XONE:96
Type	Analogue
Channels	6 + 2
EQ	4-Band: CH 1- 4 ; 3-Band, Parametric: CH A/CH B
BOOTH	3-Band EQ ; STERO/MONO ; MUTE ; Level
USB Soundcards USB1 / USB2	2 x 24 Channel ; 12 in / 12 out [6 x Stereo pairs] Hi-Speed USB2.0 [USB B] ; macOS Class Compliant [see p.24] 32bit / 96kHz 2 x MIDI IN 2 x MIDI Out
USB Inputs	2 x 6: [CH 1- 4 ; SEND1 ; MST/SEND2]
USB Outputs	2 x 6: USB1 / USB2 [CH 1- 4 ; CH A - D]
Phono Inputs	4 x RCA: CH 1- 4 LN/PH Switch for DVS
Earth Ground Terminals	x 2
Line Inputs	4 x RCA [CH 1- 4] 4 x 1/4" TRS [RTN A - D] Mono/Stereo
Mic Input	2 x XLR [MIC A / MIC B]
MST 1 Output	1 x XLR [Balanced]
MASTER INSERT	2 x 1/4" TRS [Balanced SEND / Un-balanced RETURN]
MST 2 Output	1 x 1/4" TRS [Balanced]
BOOTH Output	1 x 1/4" TRS [Balanced]
RECORD Output	1 x RCA [Un-balanced]
Send/Return I/O	2 x 1/4" TRS [SND1 / SND2] Mono/Stereo 4 x 1/4" TRS [RTN A - D] Mono/Stereo 1 x LN/Hi-Z Switch [SND 1 / RTN A]
Aux Sends	2 x CH 1- 4 + CH A, CH B [SEND1 selectable Pre/Post]
X-Link	1 x RJ45 Ethernet
Filters	2 x Stereo analogue Voltage Controlled Filters HPF / BPF / LPF Response Select ; ON/OFF [soft switched] Adjustable FREQ / RES / CRUNCH [Controlled Harmonic Signal Distortion] Assignable CH 1- 4, CH A, CH B
Channel Faders	60mm linear Voltage Controlled Amplifier [CH1 - 4, user replaceable]
Chanel Meters	9 Segment LED
Channel Fader Curve	3 Types
X-Fader	innoFADER MINI standard ; 45mm linear VCA [user replaceable]
X-Fader Curve Settings	3 Types
MIDI Assignable	Yes: MIDI CC ; MIDI Note ON/OFF
MIDI Out	USB 1 / USB2 ; 1 x 5-pin DIN ; X:Link
MIDI In	USB 1 / USB2 [CUE ; ON/OFF ; MUTE]
Power Supply	Internal switch mode power unit [SMPS] with auto sensing mains input
AC Mains	100 to 240V AC ; 50/60Hz Consumption 45W max Rear panel mounted ON/OFF switch
Mains Adaptor	3 pin IEC socket with cable clamp. Molded AC plug [supplied]

PANEL DRAWINGS, WEIGHTS & DIMENSIONS

XONE:96	UN-PACKED		PACKED	
Height	109mm	4.3"	190mm	7.5"
Width	339mm	13.4"	450mm	17.7"
Depth	410mm	16.2"	530mm	20.9"
Weight	7kg	15.4lbs	8.9kg	19.5lbs

Top Panel View

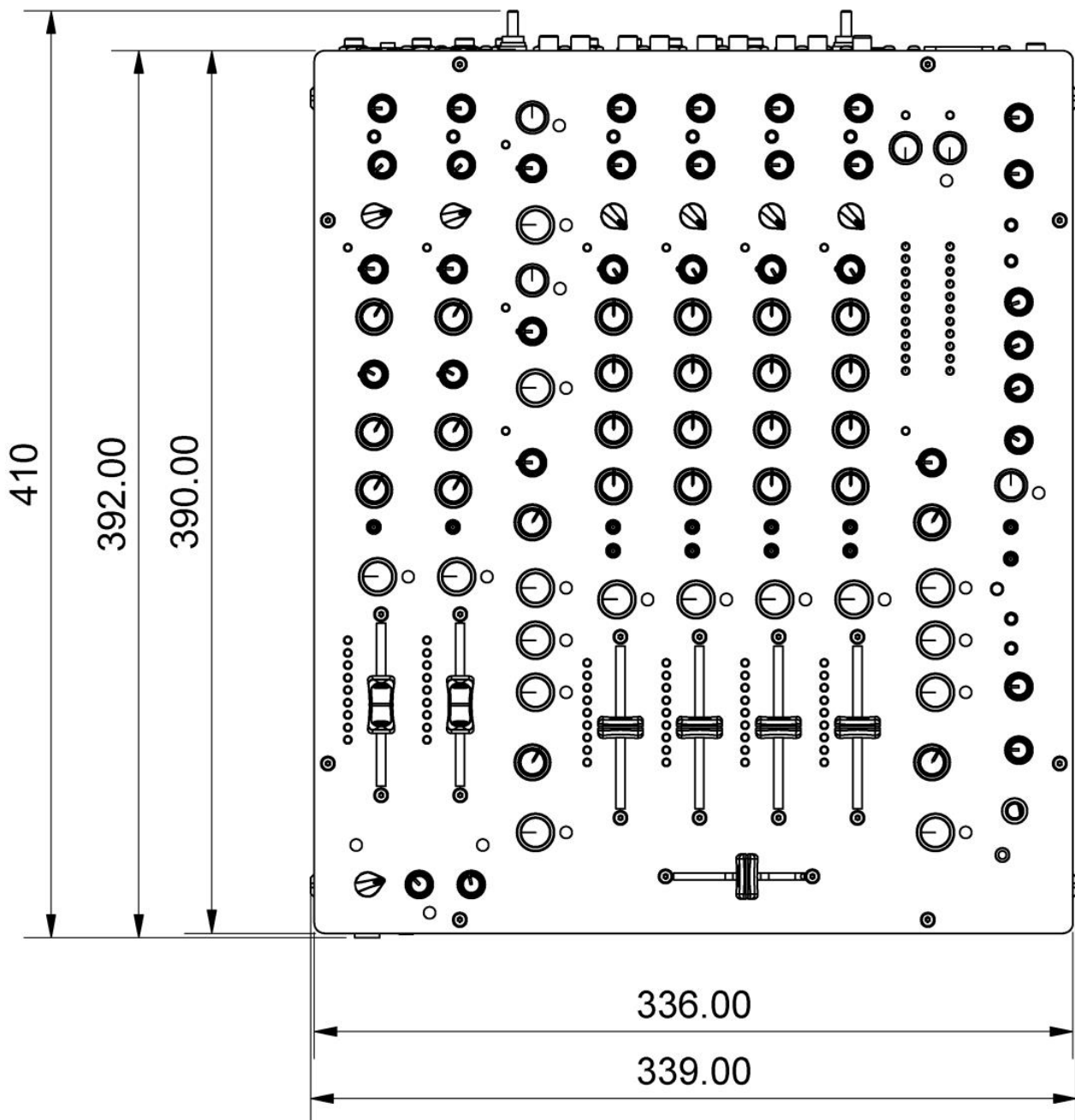

PANEL DRAWINGS continued

Rear Panel View

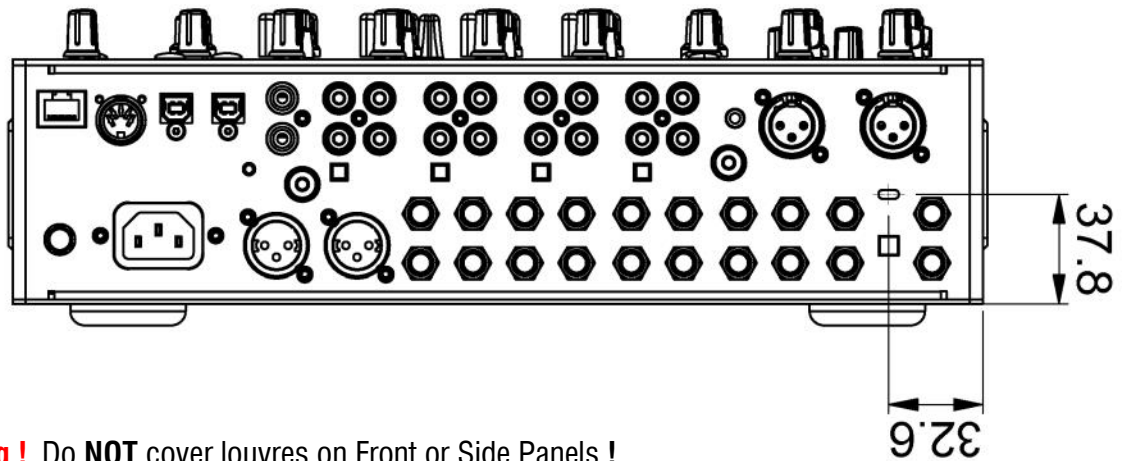

IMPORTANT Warning ! Do **NOT** cover louvres on Front or Side Panels !

NOTE: XONE:96 is **NOT** compatible with standard Xone Series or other A&H Rack Ear kits. An optional XONE:96 kit is available, designed to allow permanent fixing of the mixer into a plinth, or custom rack system:

Order A&H part code: **X.96-RKX**

Front Panel View

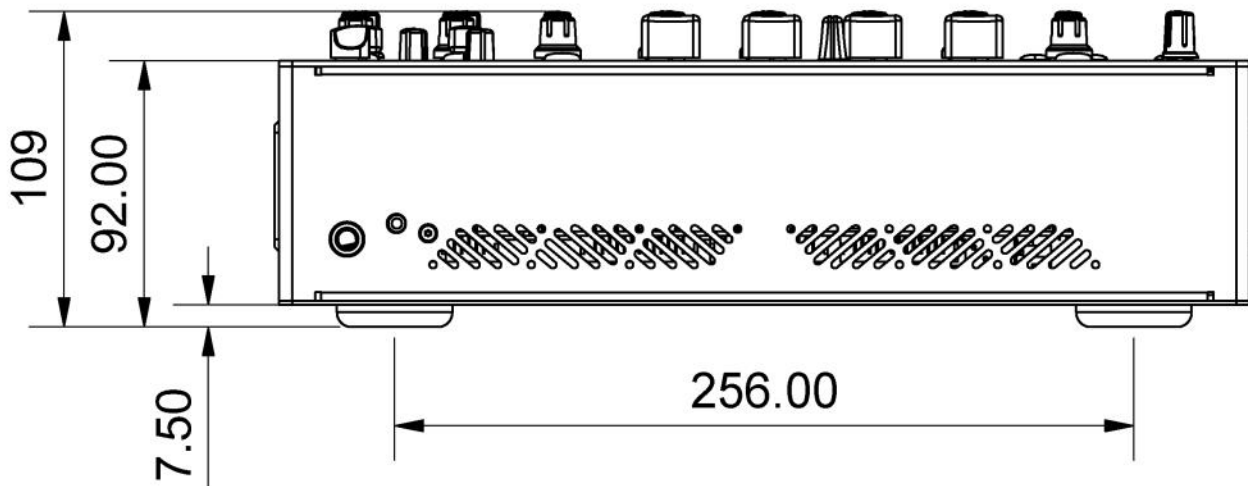

Side View [Right]

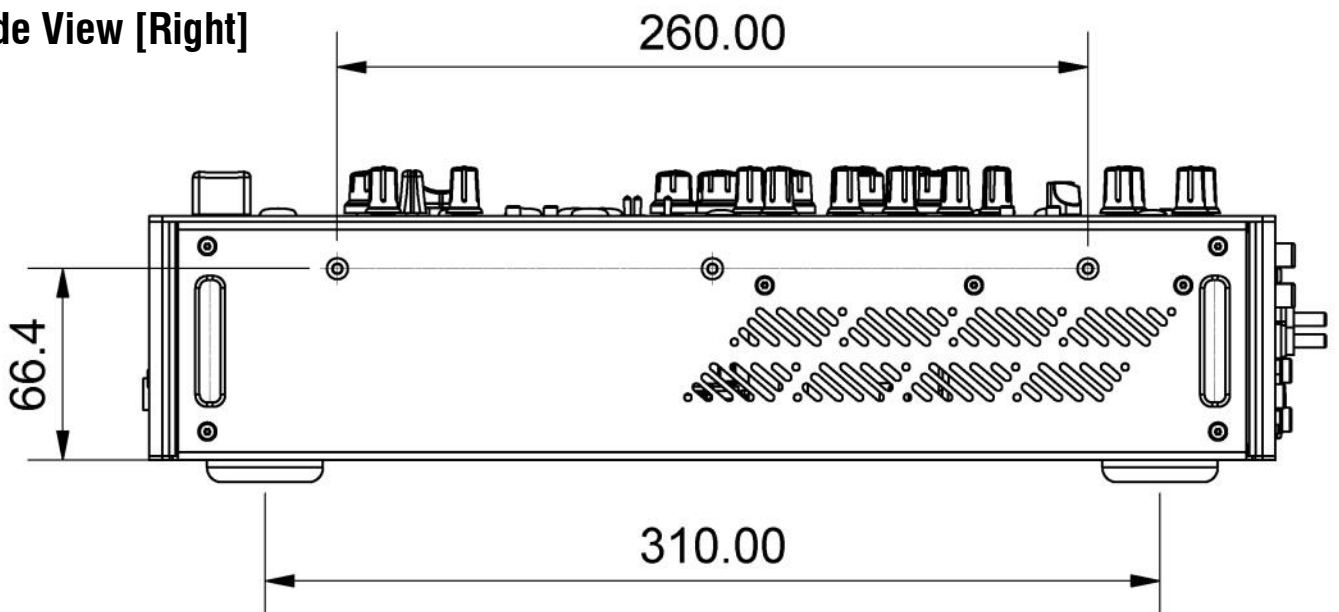

OPERATING LEVELS

It is most important that the system level settings are correctly set. It is well known that many DJs push the level to maximum with meters peaking hard in the belief that they are getting the best from the system.

THIS IS NOT THE CASE

The best can only be achieved if the system levels are set within the normal operating range and not allowed to peak. Peaking simply results in signal distortion, not more volume.

It is the specification of the amplifier / speaker system that sets the maximum volume that can be achieved, not the console. The human ear too can fool the operator into believing that more volume is needed. Be careful as this is in fact a warning that hearing damage will result if high listening levels are maintained.

Remember that it is the **QUALITY** of the sound that pleases the ear, not the **VOLUME**.

The diagram below illustrates the **NORMAL OPERATING RANGE** of the audio signal.

For normal music the signal should range between -6 and $+6$ on the meters with average around 0dB .

This allows enough **HEADROOM** for unexpected peaks before the signal hits its maximum **CLIPPING** voltage and distorts. It also achieves the best **SIGNAL-TO-NOISE-RATIO** by keeping the signal well above the residual **NOISE FLOOR** (system hiss).

The **DYNAMIC RANGE** is the maximum signal swing available between the residual noise floor and clipping.

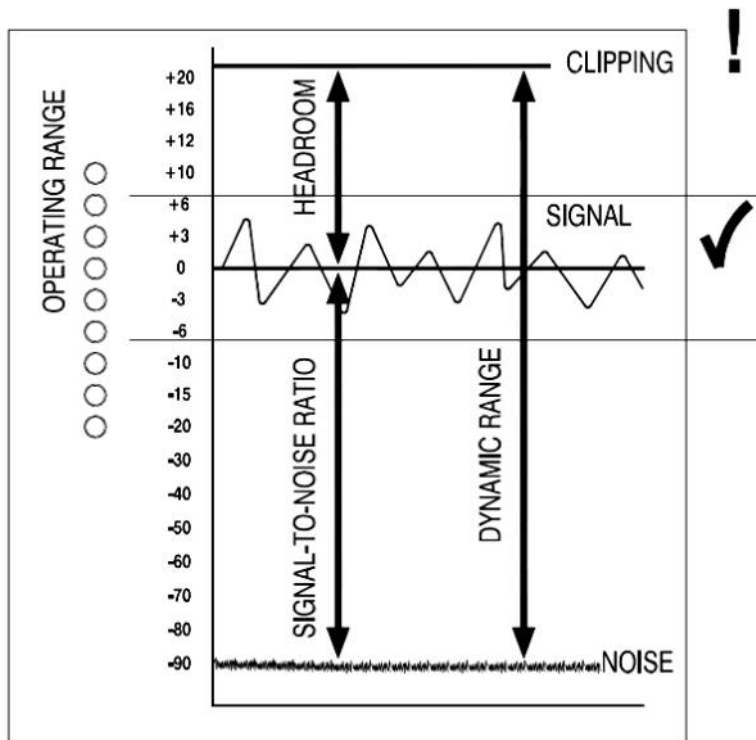

An important note ...



The human ear is a remarkable organ with the ability to compress or 'shut down' when sound levels become too high.

Do not interpret this natural response as a reason to turn the system volume up further! As the session wears on ear fatigue may set in, and the speaker cones may become hot so reducing the effectiveness of the system and listeners to gain any benefit from increased volume

EARTHING

The connection to earth (ground) in an audio system is important for two reasons:



SAFETY - To protect the operator from high voltage electric shock, and

AUDIO PERFORMANCE - To minimise the effect of earth (ground) loops which result in audible Hum and buzz, and to shield the audio signals from interference.

For safety it is important that all equipment earths are connected to mains earth so that exposed metal parts are prevented from carrying high voltage which can injure or even kill the operator.

It is recommended that a qualified system engineer check the continuity of the safety earth from all points in the system including microphone bodies, turntable chassis, equipment cases, and so on.

The same earth is also used to shield audio cables from external interference such as the hum fields associated with power transformers, lighting dimmer buzz, and computer radiation. Problems arise when the signal sees more than one path to mains earth. An 'earth loop' (ground loop) results causing current to flow between the different earth paths. This condition is usually detected as a mains frequency audible hum or buzz.

To ensure safe and trouble-free operation we recommend the following:

Have your mains system checked by a qualified electrician. If the supply earthing is solid to start with you are less likely to experience problems.

DO NOT remove the earth connection from the console mains plug. The console chassis is connected to mains earth through the power cable to ensure your safety. Audio 0V is connected to the console chassis internally. If problems are encountered with earth loops operate the audio 'ground lift' switches on connected equipment accordingly, or disconnect the cable screens at one end, usually at the destination.

Make sure that turntables are correctly earthed. A chassis earth terminal is provided on the console rear panel to connect to turntable earth straps.

Use low impedance sources such as microphones and line level equipment rated at 200 ohms or less to reduce susceptibility to interference. The console outputs are designed to operate at very low impedance to minimise interference problems.

Use balanced connections for microphones and mix output as these provide further immunity by cancelling out interference that may be picked up on long cable runs. To connect an unbalanced source to a balanced console input, link the cold input (XLR pin 3 or jack ring) to 0V earth (XLR pin 1 or jack sleeve) at the console. To connect a balanced XLR output to unbalanced equipment, link the cold output to 0V earth at the console.

Use superior quality cables and connectors and check for correct wiring and reliable solder joints. Allow sufficient cable loop to prevent damage through stretching.

If you are not sure ...

Please contact your local Allen & Heath service agent or distributor for advice: www.allen-heath.com

For more information, please visit our website: www.allen-heath.com